



**STORAGE**

**2020**

**MUJI**  
無印良品



## Designed with comfortable living space as the yardstick.

MUJI's storage furniture comes in a wide range of sizes, shapes and materials to suit a variety of purposes, preferences and lifestyles. Items are designed based on standard module dimensions to ensure that they can be used in flexible combinations and fit neatly in storage furniture. Products made to MUJI's original size standards deliver efficient use of space and enhanced comfort. MUJI storage items fit diverse user personalities and help create pleasant space.

## Storage Furniture

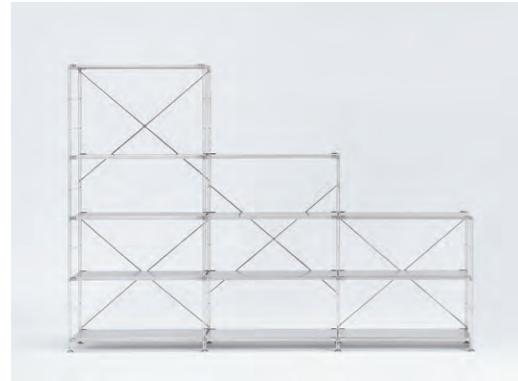

**Stainless Steel Unit Shelf** 10  
Mix and match the wide selection of optional parts to create your ideal unit shelf.



**Stacking Shelf** 16  
Extend these shelves out or up. Backless to work as a room divider, as well.



**Stacking Cabinet** 20  
Create an AV rack, bookshelves, or living room or bedroom storage to suit your particular needs.

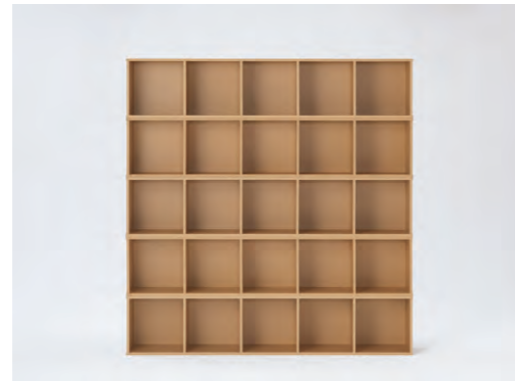

**Pulp Board Box** 23  
Light and sturdy storage boxes that can be used upright or on their side.

## Storage Items



**Polypropylene Storage Box** 26  
Storage boxes sized specifically to organise clothing. Choose the right depth and width to fit the space you have.



**Polypropylene Storage Case** 27  
Storage cases sized to hold small items and papers. Designed to fit neatly into MUJI storage furniture.

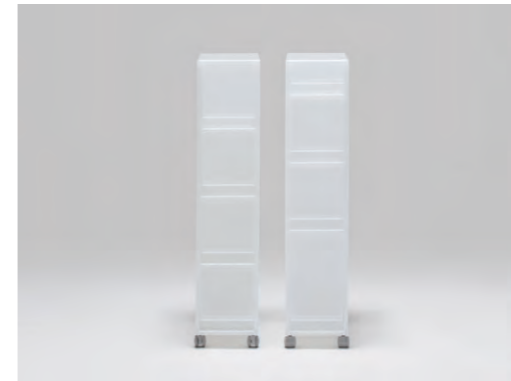

**Polypropylene 4 Drawer Trolley** 30  
Wheeled storage stockers in narrow widths for efficient use of narrow spaces.



**Soft Polyethylene Storage Unit** 31  
These storage cases make full use of the soft characteristics of polyethylene and are easy to use anywhere.

## Storage Items



**Buri Storage Unit**

32

Storage units with a natural texture, handwoven from high-quality buri wood.



**Rattan Storage Unit**

33

Storage boxes handwoven of smooth, sleek rattan.



**PP File Box**

39

Handy for storing newspapers and magazines as well as files.



**MDF Storage**

40

The surface is finished with ash to blend in the interior. Convenient sized storage to organize things on your desk.



**Cotton Linen Storage Unit**

34

Foldable storage boxes made from fabric coated on the inside.



**Stainless Steel Storage Unit**

35

Stackable wire baskets that are highly durable. The handles can be folded inside when stacking the baskets.



**Cardboard File Box**

40

Self-assembly type cardboard file boxes can be folded flat and put away when not in use.



**Acrylic Storage Unit**

41

Versatile storage units suitable for organising small items such as stationery and jewellery.



# Stainless Steel Unit Shelf

Stainless Steel Unit Shelves made with selectable parts to match your style and usage. Create your own functional shelf for any purpose, from laundry rack to wardrobe, bookshelf, and desk.

## Basic configuration of unit shelf

The unit shelf consists of a frame, shelf boards and cross bars. Assembly is simple and the position of the shelf boards can be adjusted at 18.5 cm intervals.

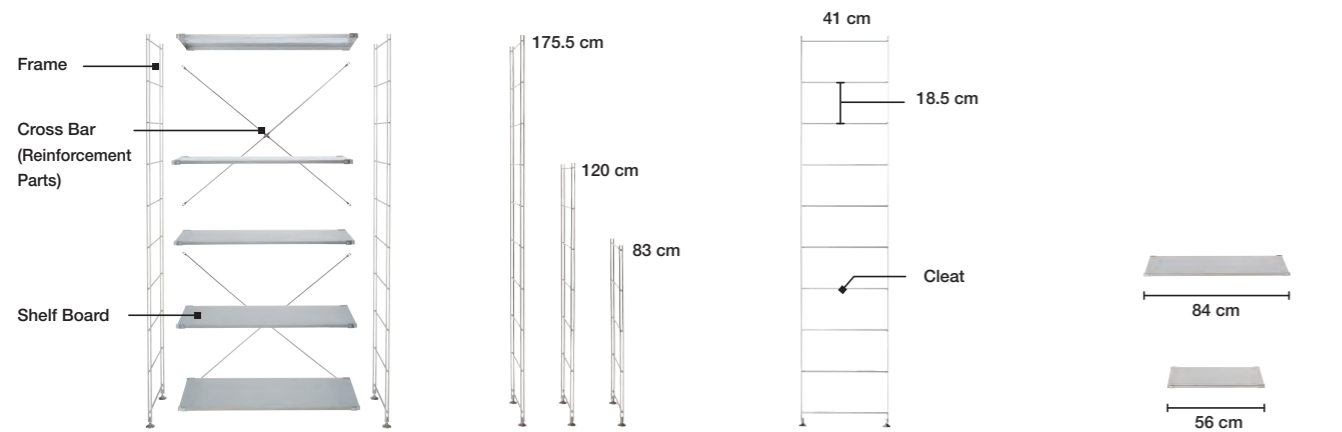

The shelf is assembled by combining the frame and the shelf boards.

You can choose from three heights.

The depth is 41 cm.

You can choose from two widths.

## Examples of unit shelf combinations

You can make your own original shelf by mixing and matching the selectable parts, such as shelf boards or frames. Create your own shelf to match your style and usage.



SUS Oak Shelf Set Wide/Large



Walnut Shelf Set/Medium



SUS Oak Shelf Set/Wide/Medium, SUS Additional Stainless Frame/Medium x 2 Additional Shelf/Corner Type x 4, SUS Additional S/S Crossbar/Large

## Configurations Recommended by MUJI Interior Advisors

The following unit shelf configurations are recommended by MUJI Interior Advisors.



### Two unit shelves next to each other against the wall

This is a basic configuration. You can change the position of the shelf boards, add various storage items and arrange it as you like.



### Two side cabinets

This combination is good for under a window or as a counter. Creating open space below the bottom shelf by extending the legs facilitates cleaning and makes the room look bigger.



### Laundry

Your wardrobe can be stored in three ways; by "Hanging on the bar", "placing on the selves" and "putting away in the drawers".



### Small Storage Space

This is a recommended configuration of slim units for convenient storage for small space. It can meet various purposes in the kitchen, living room, laundry and other areas.

## Stainless Unit Shelf

**Set** The basic combinations are provided as sets in different sizes.  
\*Depth for all types is 41 cm



**Stainless Shelf Set** NEW  
02999032 | Wide / Large **\$509.00**  
02999063 | Large **\$459.00**  
02999049 | Wide / Medium **\$459.00**  
02999070 | Medium **\$349.00**  
02999056 | Wide / Small **\$339.00**  
02999087 | Small **\$279.00**



**SUS Oak Shelf Set**  
37238992 | Wide / Large **\$609.00**  
37236493 | Large **\$509.00**  
37239005 | Wide / Medium **\$509.00**  
37238978 | Medium **\$459.00**  
37239012 | Wide / Small **\$389.00**  
37238985 | Small **\$339.00**



**Walnut Shelf Set**  
37236462 | Wide / Large **\$629.00**  
37236424 | Large **\$529.00**  
37236479 | Wide / Medium **\$529.00**  
37236431 | Medium **\$469.00**  
37236486 | Wide / Small **\$399.00**  
37236455 | Small **\$349.00**



In order to reduce warping, a change was made in 2019 to the shape of the hooks for the Stainless Steel Shelves and Steel Shelves, only limited to Light Grey.  
\*There is compatibility between old and new.

**Shelf Board** There are four different materials and forms available. Choose the one that will suit your room and needs.

**SUS Additional Shelf Oak**  
37167025 | For W 84 cm **\$89.00**  
37167032 | For W 56 cm **\$69.00**

**SUS Additional Shelf Walnut**  
37167056 | For W 84 cm **\$99.00**  
37167063 | For W 56 cm **\$79.00**

**Additional Shelf / Stainless Steel Wire**  
61179322 | For W 84 cm **\$79.00**  
61179339 | For W 56 cm **\$59.00**  
\* "Extendable Parts for Stainless Steel Unit Shelf" and "Height Adjustment Bracket" cannot be installed.

**Additional Shelf / Stainless Steel** NEW  
02998509 | For W 84 cm **\$79.00**  
02998516 | For W 56 cm **\$59.00**

**Additional Shelf / Dark Grey**  
37414488 | For W 84 cm **\$49.00**  
37414495 | For W 56 cm **\$39.00**

**Additional Shelf / Light Grey**  
37414525 | For W 84 cm **\$49.00**  
37414532 | For W 56 cm **\$39.00**

[Withstand Load]  
Each shelf: Approx. 30 kg  
H 175.5 cm type: Max. 100 kg  
H 120 cm type: Max. 75 kg  
H 83 cm type: Max. 50 kg  
\*When load is distributed evenly across the entire unit.

[Effective Inside Dimensions]  
W 84 cm type: W 80 x D 39.5 cm  
W 56 cm type: W 52 x D 39.5 cm

**Cross Bar** These reinforcement parts reduce the shakiness and steady the shelf.

**SUS Additional S/S Crossbar**  
61179261 | Large / for W 84 cm **\$26.00**  
61179278 | Small / for W 42-56 cm **\$23.00**

**Frame** A part that supports the shelf boards. You can make your own original shelf by connecting them horizontally and by choosing the height.

**Additional Shelf Frame**  
61179223 | Large / for H 175.5 cm **\$109.00**  
61179230 | Medium / for H 120 cm **\$89.00**  
61179247 | Small / for H 83 cm **\$59.00**

**Shelf Board - Corner Type** This is L-shaped shelf board. By changing the position of the metal fittings, you can change the direction of the connection.



**Additional Shelf / Corner Type**  
37413887 | Oak **\$149.00**  
37413894 | Walnut **\$159.00**  
[Withstand Load] Shelf board: Approx. 30 kg  
[Effective Inside Dimensions]

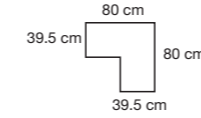

\* If you use an Additional Shelf / Corner Type without attaching it to another shelf, Reinforcement Parts and Cross Bars are necessary to strengthen the unit. Depending on the combination, the number or type of pieces required may vary.

**Optional Parts** Choose individual components to achieve your desired configuration.



**Height Adjustable Bracket**  
76580850 | Set of 4 **\$19.00**

\* Shelves with Height Adjustable Brackets attached can be raised up approximately 9.5 cm higher.  
\* This item cannot be attached to Additional Shelf / Corner Type or Additional Shelf / Narrow Type.



**Caster / Grey**  
61179780 | Set of 4 **\$19.00**

\* Do not use the casters with L-sized frames.  
\* Changing the adjusters to casters increases the total height by 5.1 cm.  
\* When using casters, consider the withstand load to be half of the withstand load of when used without casters.

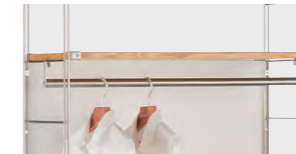

**Wardrobe Bar**  
61179797 | For W 84 cm **\$33.00**  
61179803 | For W 56 cm **\$29.00**

Withstand Load: 10 kg  
\* It can also be used on Steel Unit Shelf.

**Wooden Storage Case** This item can be used by itself on the floor or in combination with a unit shelf.



**Wooden Storage Case / 2 Drawers / Wide** NEW  
82011319 | Oak **\$99.00**  
02528546 | Walnut **\$109.00**

Approx. W 52 x D 37 x H 34.5 cm  
Withstand load: approx. 5 kg on top board, approx. 5 kg per drawer



**Wooden Storage Case / 4 Drawers / Wide** NEW  
82011357 | Oak **\$139.00**  
02528676 | Walnut **\$149.00**

Approx. W 52 x D 37 x H 34.5 cm  
Withstand load: approx. 5 kg on top board, approx. 2 kg per drawer



**Wooden Storage Case / Open / Wide** NEW  
82011364 | Oak **\$59.00**  
02528683 | Walnut **\$73.00**

Approx. W 52 x D 37 x H 34.5 cm  
Withstand load: approx. 5 kg on top board, approx. 5 kg on bottom board



**Wooden Storage Case / 2 Drawers** NEW  
82011302 | Oak **\$63.00**  
02528539 | Walnut **\$79.00**

Approx. W 26 x D 37 x H 34.5 cm  
Withstand load: approx. 3 kg on top board, approx. 3 kg per drawer



**Wooden Storage Case / 4 Drawers** NEW  
82011340 | Oak **\$109.00**  
02528669 | Walnut **\$119.00**

Approx. W 26 x D 37 x H 34.5 cm  
Withstand load: approx. 3 kg on top board, approx. 1 kg per drawer

\* In the event where the product is placed on furniture, etc., do not place the product higher than 46.5cm above the floor.

\* In the event where the product is placed on the shelf or top board inside storage furniture where the product is placed in a stable manner, do not place the product higher than 85 cm above the floor.

**Panel** A part to reduce swaying and be used as a partition.



**Back Panel / Dark Grey (2 Compartment Type)**  
76580997 | For W 84 cm **\$26.00**  
76581000 | For W 56 cm **\$23.00**



**Back Panel / Dark Grey (3 Compartment Type)**  
76580775 | For W 84 cm **\$39.00**  
76580782 | For W 56 cm **\$33.00**



**Side Panel / Dark Grey**  
76580904 | S / 2 Compartment Type **\$23.00**  
76581406 | L / 3 Compartment Type **\$33.00**



If used by itself on the floor, two units can be stacked vertically and connected with metal joint fittings.

# Steel Unit Shelf

**Sets** Basic sets available in two different widths and four different heights.

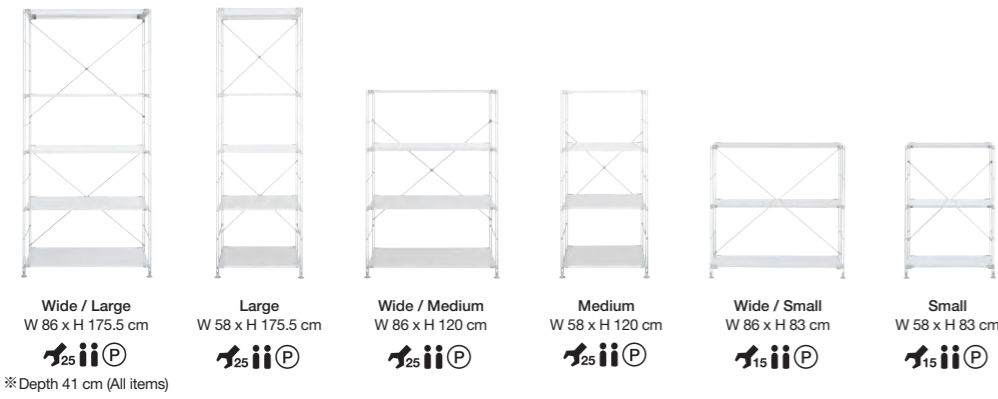

- ※ Depth 41 cm (All items)
- D 41 cm / Steel Shelf Set / Light Grey** NEW
- 02999094 | Wide/ Large **\$279.00**
  - 02999131 | Large **\$219.00**
  - 02999100 | Wide/ Medium **\$209.00**
  - 02999148 | Medium **\$169.00**
  - 02999117 | Wide/ Small **\$159.00**
  - 02999155 | Small **\$139.00**



**Unit Shelf / Wardrobe Bar**

- 61179797 | For W 84 cm **\$33.00**
- 61179803 | For W 56 cm **\$29.00**

Withstand load: 10kg



**Height Adjustment Bracket / Light Grey For Steel Unit Shelf** NEW

02998851 | Set of 4 **\$13.90**



**Height Adjustment Bracket / Grey For Steel Unit Shelf**

76580867 | Set of 4 **\$13.90**

※ Up to three sets of height adjustment brackets (for three shelf boards) can be used on one unit shelf.  
 ※ With height adjustment brackets, the level of the shelf board height can be increased by approx. 9.5 cm  
 ※ You may also use a shelf board that does not use height adjustment brackets concurrently.  
 ※ It cannot be attached to "Additional Shelf/Stainless Steel Wire", "Additional Shelf/Corner" and "Additional Small Shelf/D 12 cm".

## Shelf Board

Choose one according to the space and items to be stored.

**D 41 cm / Additional Shelf / Steel / Light Grey** NEW

- 02998547 | For W 84 cm **\$33.00**
- 02998554 | For W 56 cm **\$29.00**

**D 41 cm / Additional Shelf / Steel / Grey**

- 61179551 | For W 84 cm **\$33.00**
- 61179568 | For W 56 cm **\$29.00**

※ Special Order

**D 41 cm / Additional Shelf / Wooden / Grey**

- 61179582 | For W 84 cm **\$49.00**
- 61179599 | For W 56 cm **\$39.00**

\* Special Order

## Shelf Frame

A part that supports the shelf boards. You can make your own original shelf by connecting them horizontally and by choosing the height.

**D 41 cm / Additional Shelf Frame / Light Grey** NEW

- 02998394 | For Large / H 175.5 cm **\$49.00**
- 02998387 | For Medium / H 120 cm **\$39.00**
- 02998370 | For Small / H 83 cm **\$29.00**

**D 41 cm / Additional Shelf Frame / Grey**

- 61179629 | For Large / H 175.5 cm **\$49.00**
- 61179636 | For Large / H 120 cm **\$39.00**
- 61179643 | For Large / H 83 cm **\$29.00**

※ For Additional Shelf Frame/Extra Large, be sure to use the attached fixing brackets, and place the shelf unit in contact with the wall.

## Crossbar

Reinforcing parts to reduce the shaking of the shelf unit.

**Crossbar / Light Grey** NEW



- 02998738 | For Large / W 84 cm **\$10.90**
- 02998745 | For Small / W 42-56 cm **\$9.90**

**Crossbar / Grey**

- 61179667 | For Large / W 84 cm **\$10.90**
- 61179674 | For Small / W 42-56 cm **\$9.90**

## Reference Table for Required Number of Unit Shelf Parts

To ensure a certain level of stability for Unit Shelves, a specified number of parts are required for assembly. Refer to the table below for the minimum number of parts required for your particular configuration.

Frame size				
		Large	Medium	Small
W 84 cm	Shelf Boards For Frame	3	3	2
	Cross Bar / Large	2	1	1
W 56 cm	Shelf Boards For Frame	3	3	2
	Cross Bar / Small	2	1	1

※ The stability may also vary depending on the location of the assembled parts. The stability of the unit may decrease if the shelf boards are not evenly spaced, even if more than the required number of parts are used.  
 In particular, if you do not use a shelf board at the top or bottom of the unit, or if you leave an excess space between the shelves, it may cause the unit to be unstable. Make sure to install the shelf boards evenly spaced.  
 ※ The required number of parts may vary depending on the configuration when Cross Bars are used to replace the Back Panel.

[Withstand load of D 41 cm type]

Each shelf: approx. 30 kg  
 H 175.5 cm type: Max. 100 kg  
 H 120 cm type: Max. 75 kg  
 H 83 cm type: Max. 50 kg  
 H 46 cm type: Max. 30 kg

※ When load is distributed evenly across the entire unit

[Inside dimensions of D 41 cm type]

W 84 cm type: W 80 × D 39.5 cm  
 W 56 cm type: W 52 × D 39.5 cm  
 W 42 cm type: W 38 × D 39.5 cm



# Stacking Shelf

A shelf which can be extended both vertically and horizontally to suit various needs. It can be used as a bookshelf, a decorative shelf, or even as a room dividing shelf. A wide type is also available to suit different applications.



Combination price **\$538.00**  
Narrow 3 Shelf (Basic Set), Wide 3 Shelf (Add On)

## Basic configuration of stacking shelf

The units can be easily linked by connecting the steel pipes inside the dividers and fastening them with the bolts. MUJI's storage items fit nicely in these shelves.

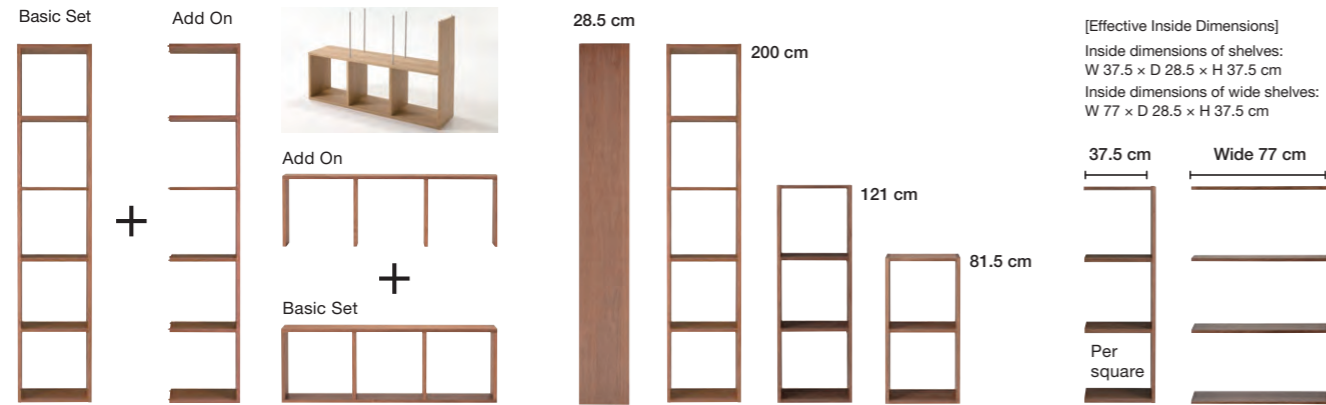

By combining a basic set with additional sets, you can extend the shelves vertically and horizontally to achieve your desired configuration.

This item is only available in depth 28.5 cm. You can choose from three heights.

You can choose from two block widths.

## Set

A variety of sets are available to suit a wide range of needs.

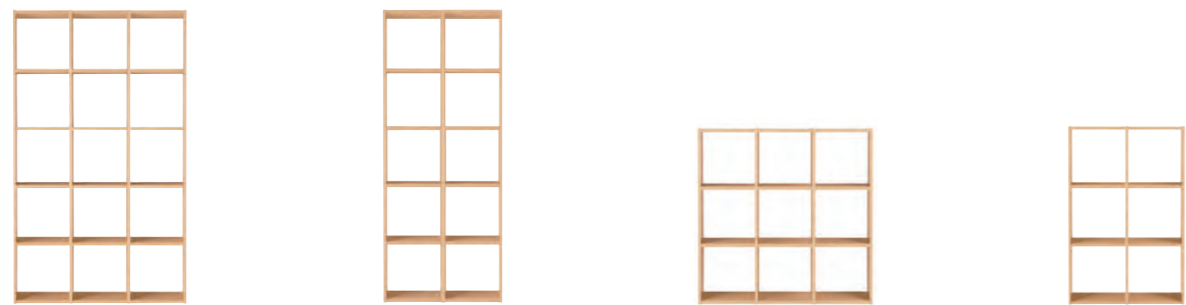

5 x 3 W 122 x H 200 cm  
5 x 2 W 82 x H 200 cm  
3 x 3 W 122 x H 121 cm  
3 x 2 W 82 x H 121 cm  
※Depth for all types is 28.5 cm

Stacking Shelf Set 5 x 3		Stacking Shelf Set 5 x 2		Stacking Shelf Set 3 x 3		Stacking Shelf Set 3 x 2	
38932253   Oak	<b>\$729.00</b>	38932260   Oak	<b>\$519.00</b>	38932277   Oak	<b>\$609.00</b>	38932284   Oak	<b>\$399.00</b>
38932451   Walnut	<b>\$799.00</b>	38932468   Walnut	<b>\$569.00</b>	38932475   Walnut	<b>\$699.00</b>	38932482   Walnut	<b>\$469.00</b>
Withstand load: 20 kg per shelf, 90 kg total		Withstand load: 20 kg per shelf, 60 kg total		Withstand load: 20 kg per shelf, 60 kg total		Withstand load: 20 kg per shelf, 40 kg total	



※ The characteristics of natural wood, such as the colour and grain pattern, may vary in appearance depending on the material.  
※ Assembly needs to be performed in an area with enough space to lay the shelf unit on its side.  
※ Withstand loads are calculated based on evenly distributed weight.

## Basic Set

The basic set comes in three types: 5 shelf, 3 shelf and 2 shelf, and two widths.

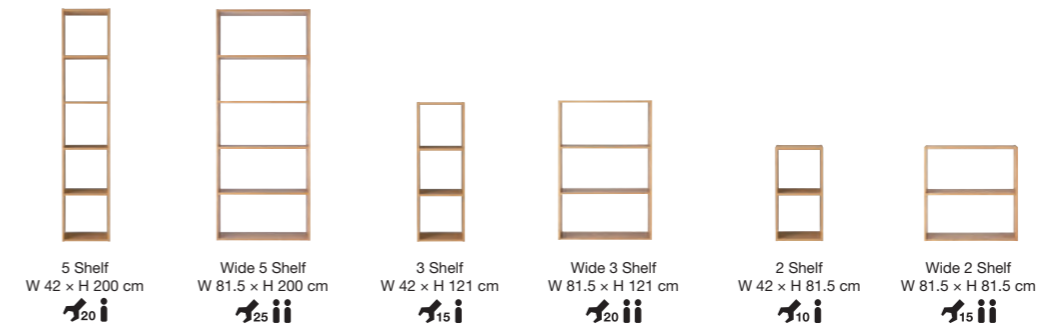

※Depth for all types is 28.5 cm

5 Shelf (Basic Set)		3 Shelf (Basic Set)		2 Shelf (Basic Set)	
38932116   Oak	<b>\$309.00</b>	38932109   Oak	<b>\$239.00</b>	38932093   Oak	<b>\$199.00</b>
38932314   Walnut	<b>\$339.00</b>	38932307   Walnut	<b>\$279.00</b>	38932291   Walnut	<b>\$229.00</b>
Wide 5 Shelf (Basic Set)		Wide 3 Shelf (Basic Set)		Wide 2 Shelf (Basic Set)	
38932178   Oak	<b>\$399.00</b>	38932161   Oak	<b>\$329.00</b>	38932154   Oak	<b>\$279.00</b>
38932376   Walnut	<b>\$439.00</b>	38932369   Walnut	<b>\$359.00</b>	38932352   Walnut	<b>\$309.00</b>

[Withstand Load]  
5 Shelf, Wide 5 Shelf (Basic Set)  
Withstand load: 20 kg per shelf, 60 kg total  
3 Shelf, Wide 3 Shelf (Basic Set)  
Withstand load: 20 kg per shelf, 40 kg total  
2 Shelf, Wide 2 Shelf (Basic Set)  
Withstand load: 20 kg per shelf, 30 kg total

## Add On

By combining a basic set with additional sets, you can extend the shelves vertically and horizontally.

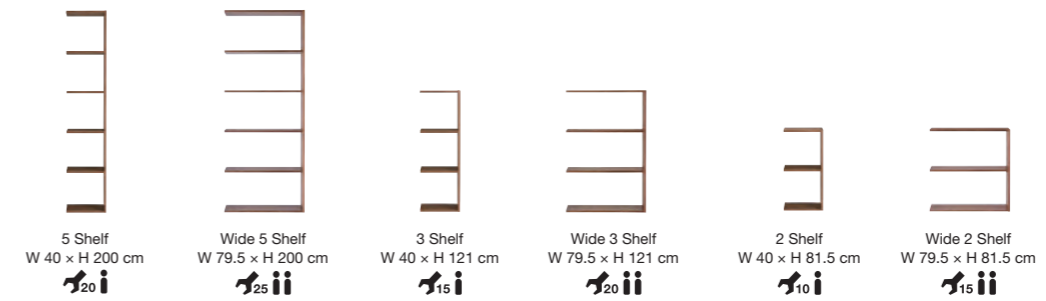

※Depth for all types is 28.5 cm

5 Shelf (Add On)		3 Shelf (Add On)		2 Shelf (Add On)	
37263208   Oak	<b>\$279.00</b>	37263192   Oak	<b>\$229.00</b>	37263185   Oak	<b>\$179.00</b>
37265677   Walnut	<b>\$309.00</b>	37265660   Walnut	<b>\$259.00</b>	37265653   Walnut	<b>\$209.00</b>
Wide 5 Shelf (Add On)		Wide 3 Shelf (Add On)		Wide 2 Shelf (Add On)	
37263260   Oak	<b>\$369.00</b>	37263253   Oak	<b>\$309.00</b>	37263246   Oak	<b>\$259.00</b>
37265738   Walnut	<b>\$399.00</b>	37265721   Walnut	<b>\$339.00</b>	37265714   Walnut	<b>\$289.00</b>

[Withstand Load]  
5 Shelf, Wide 5 Shelf (Add On)  
Withstand load: 20 kg per shelf, 60 kg total  
3 Shelf, Wide 3 Shelf (Add On)  
Withstand load: 20 kg per shelf, 40 kg total  
2 Shelf, Wide 2 Shelf (Add On)  
Withstand load: 20 kg per shelf, 30 kg total

## Open Type Add On Set

Please use in combination with 5 Shelf Basic Set.

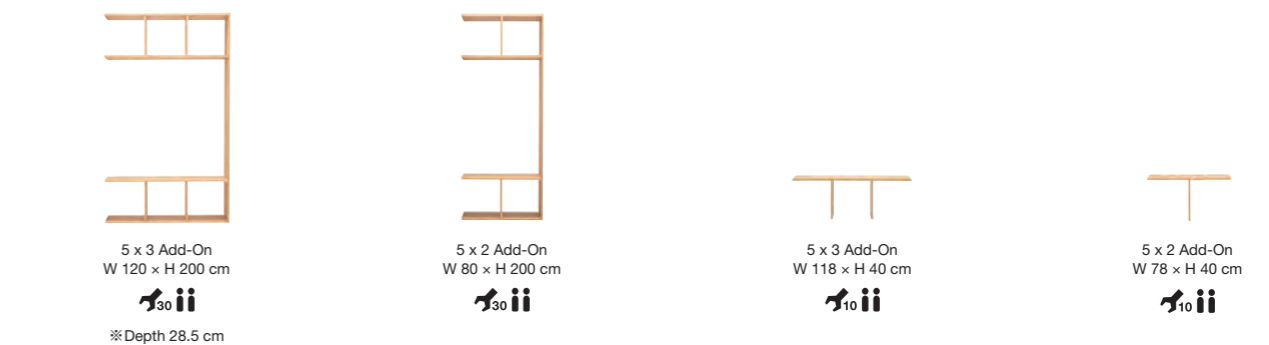

5 x 3 Add-On / Open		5 x 2 Add-On / Open		5 x 3 Add-On / Open		5 x 2 Add-On / Open	
38932215   Oak	<b>\$499.00</b>	38932239   Oak	<b>\$399.00</b>	37263284   Oak	<b>\$199.00</b>	37263307   Oak	<b>\$129.00</b>
38932413   Walnut	<b>\$569.00</b>	38932437   Walnut	<b>\$479.00</b>	37265752   Walnut	<b>\$229.00</b>	37267046   Walnut	<b>\$159.00</b>
Opening: W 116.5 x D 28.5 x H 116.5 cm Withstand Load Upper row: 20 kg in total, Centre Board: 3 column 40 kg, 2 column 30 kg		Opening: W 77 x D 28.5 x H 116.5 cm		Withstand Load Top Board: 40kg		Withstand Load Top Board: 30kg	

※ It cannot be placed horizontally.  
※ It cannot be combined with Wide/5 Shelf (Basic Set).

※ The material used inside the drawers (MDF) may have a distinct smell. Although the smell will fade with use, it is recommended to avoid storing clothing or other items that can absorb odour inside the drawers.

### Optional Parts for Stacking Shelf

This item can be used by itself or in combination with a stacking shelf.



**2 Tier**  
02554057 | Oak **\$109.00**  
02554088 | Walnut **\$129.00**  
W 37 × D 28 × H 37 cm  
Withstand load: Top board 5 kg, each  
drawer 3 kg, total 5 kg  
Inside dimensions of drawer: W 33.5 ×  
D 24.5 × H 15.5 cm



**4 Tier**  
02554071 | Oak **\$129.00**  
02554101 | Walnut **\$149.00**  
W 37 × D 28 × H 37 cm  
Withstand load: Top board 5 kg, each  
drawer 2 kg, total 5 kg  
Inside dimensions of drawer: W 33.5 ×  
D 24.5 × H 6 cm



**4 Drawer**  
02554064 | Oak **\$129.00**  
02554095 | Walnut **\$149.00**  
W 37 × D 28 × H 37 cm  
Withstand load: Top board 5 kg, each  
drawer 2 kg, total 5 kg  
Inside dimensions of drawer: W 15 ×  
D 24.5 × H 15.5 cm

When stacking the chests vertically, use the architrave for stacking chest 02874346 | Oak or 02874353 | Walnut and Pulp Shelf Clamps 18960941 (P23).  
\*Up to two chests can be stacked vertically.



**1 Drawer**  
02528720 | Oak **\$49.00**  
02528737 | Walnut **\$63.00**  
W 37 × D 28 × H 18.5 cm  
Withstand load: Top board 5 kg, each  
drawer 2 kg, total 5 kg  
Inside dimensions of drawer: W 33.5 ×  
D 24.5 × H 15.5 cm



**2 Tier**  
02528706 | Oak **\$63.00**  
02528713 | Walnut **\$76.00**  
W 37 × D 28 × H 18.5 cm  
Withstand load: Top board 5 kg, each  
drawer 3 kg, total 5 kg  
Inside dimensions of drawer: W 33.5 ×  
D 24.5 × H 6 cm



**2 Drawer**  
02528515 | Oak **\$63.00**  
02528522 | Walnut **\$76.00**  
W 37 × D 28 × H 18.5 cm  
Withstand load: Top board 5 kg, each  
drawer 3 kg, total 5 kg  
Inside dimensions of drawer: W 15 ×  
D 24.5 × H 15.5 cm



**Open Chest / Half**  
02528744 | Oak **\$43.00**  
02528751 | Walnut **\$56.00**  
W 37 × D 27 × H 18.5 cm  
Withstand load: Top board 5 kg, total 5 kg

## Structure of the Stacking Shelves

Original storage furniture can be freely created by combining a basic set with additional sets. As shown below, the units can be easily linked by connecting the steel pipes within the dividers and fasten them with bolts.

### Stacking mechanism

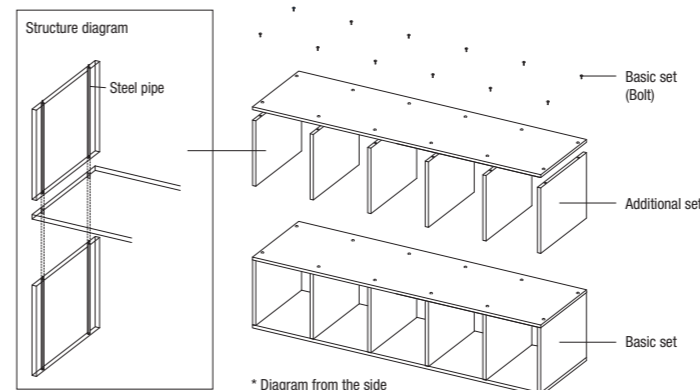

### Example of combination and withstand load

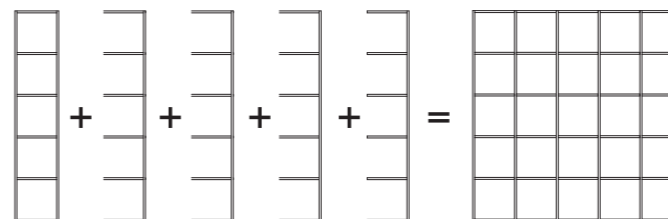

A combination method consisting of a shelf in the upright direction and additional units linked to the side.

Withstand load: 150 kg total = 60 kg × 5 units ÷ 2

Total withstand load when shelves are combined = Withstand load of set × number of units ÷ 2



A combination method consisting of a shelf placed sideways and additional units linked on top.

Withstand load: 40 kg total = 40 kg × 2 units ÷ 2

Total withstand load when shelves are combined = Withstand load of set × number of units ÷ 2

## Example of Usage

### Combination of differing tiers

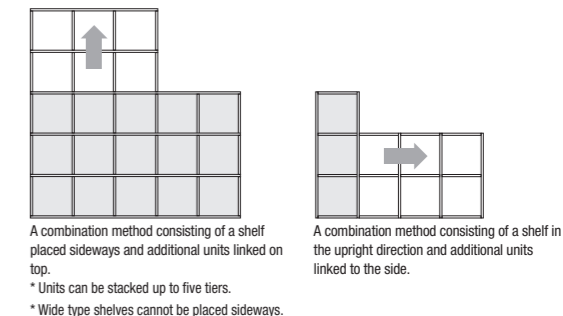

### Combination of items with differing widths

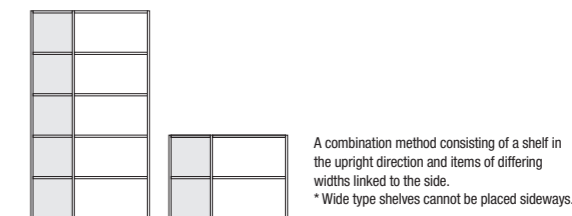

### Using as a partition

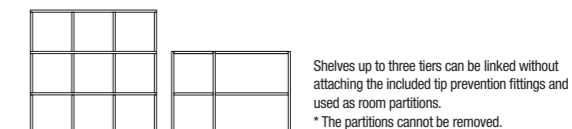

## Open Structure of the Stacking Shelf

Free storage can be created by combining open parts with steel pipes to the basic set. The combination is basically the following two patterns. (Common to 2 and 3 rows).

### Combination Pattern 1

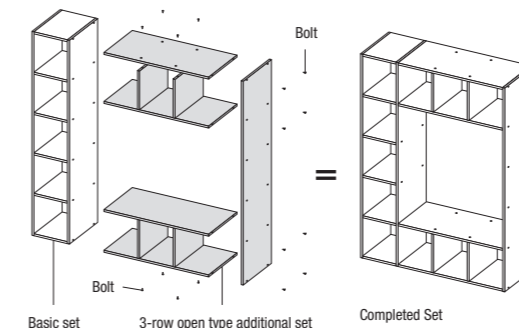

### Combination Pattern 2

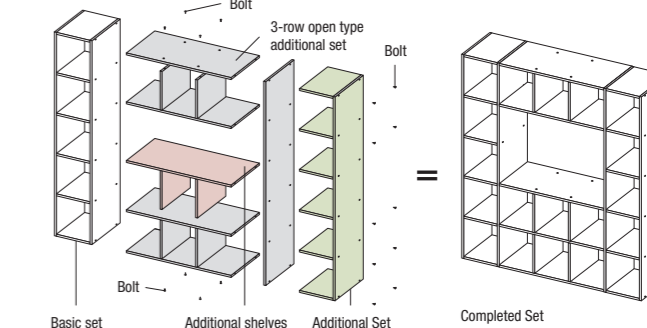



## Stacking Cabinet

Your customized storage cabinet can be formed by combining add on items to the basic set. It can be used in various ways according to the application, as AV racks, bookshelves, living and bedroom storage shelves.



Combination price **\$1048.00**  
162.5cm (Basic Set) and W162.5 cm Add-On set/High

### Structure of the Stacking Cabinet

Stacking (overlapping) to make it easy to use,  
A convenient cabinet can be made by combining optional parts.

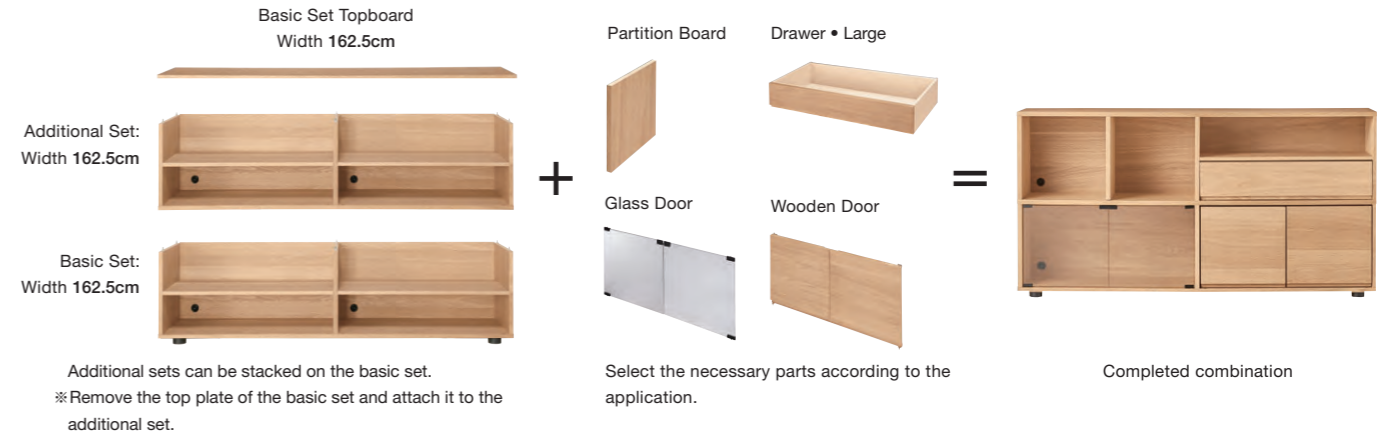

**Basic Unit** Basic Unit can be used by itself or in combination with add on sets.



**W 162.5 cm (Basic Unit)**  
38918073 | Oak **\$479.00**  
W 162.5 × D 39.5 × H 45 cm  
Withstand load: Top board 65kg, 5 kg per shelf (both shelves of W78 cm and W37.5 cm)  
20 ii P



**W 82.5 cm (Basic Unit)**  
38918080 | Oak **\$289.00**  
W 82.5 × D 39.5 × H 45 cm  
Withstand load: Top board 40 kg, 5 kg per shelf  
15 ii P



**W 162.5 cm (Add-On Set)**  
38917908 | Oak **\$429.00**  
W 162.5 × D 39.5 × H 40 cm  
Inside dimensions of a shelf (without middle shelf board, without door): W78 x D38 x H17.5 cm  
20 ii P



**W 82.5 cm (Add-On Set)**  
38917915 | Oak **\$249.00**  
W 82.5 × D 39.5 × H 40 cm  
Inside dimensions of a shelf (without middle shelf board, without door): W 78 x D 38 x H 17.5 cm  
15 ii P



**W 162.5 cm / High Type (Add-On Set)**  
38917939 | Oak **\$569.00**  
W 162.5 × D 39.5 × H 79.5 cm  
Inside dimensions of a shelf  
(Large): W 118 x D 38 x H 77 cm  
(Small): W 37.5 x D 38 x H 77 cm with one adjustable shelf  
※ The top board on High unit has a withstand load of 30 kg.  
※ By switching the vertical partition from the left to right or vice versa, the position of the wide opening can be changed.  
※ The effective inner dimension of the cord hole is 2.5 cm.  
※ The high type (Add-On) is only allowed to be used as the bottom unit. Only one Add-On unit can be stacked on top of it. (Only for W162.5 cm type)  
25 ii P



※ Natural wood has individual differences in colour and grain due to the characteristics of the material.  
※ The withstand load indicated here is measured when a load is applied evenly.

**Additional Parts** Parts can be added depending on the application.



**Dividing Board**  
38917892 | Oak **\$39.00**  
Thickness 2.5 × D 37.5 × H 37.5 cm  
※It cannot be used together with wooden doors and glass doors.



**Glass Door (Set of 2, left and right)**  
38917861 **\$59.00**  
※It can be used for both Oak and Walnut series.  
※If the doors are installed later, the bottom board of the main unit needs to be removed temporarily.  
※The inner dimension of the main unit when the glass doors are installed, is approximately 37cm.  
※The glass doors can be installed only on the button unit. They cannot be used on the stacked units in the 2nd or higher tiers.



**Drawer - Large**  
38917885 | Oak **\$79.00**  
W 77.5 × D 37.5 × H 17.5 cm  
Inside dimensions of drawer: W75 × D32.5 × H15.5cm Withstand load: 5kg  
※The drawer can be installed up to 125cm in height from the floor.



**Wooden Door (Set of 2, left and right)**  
38917878 | Oak **\$79.00**  
※If the doors are installed later, the top board of the main unit needs to be removed temporarily.  
※The inner dimension of the main unit when the wooden doors are installed, is approximately 36cm.

**Pulp Board Box**

Light and sturdy storage boxes which can be used upright or on its side. Up to five of these units can be stacked on its side to form a wall storage system. From A4-sized units to slim-sized models, a variety of shapes and sizes are available to choose from.



\* Usage example

\* When stacking units on their side, use the Pulp Shelf Clamps.

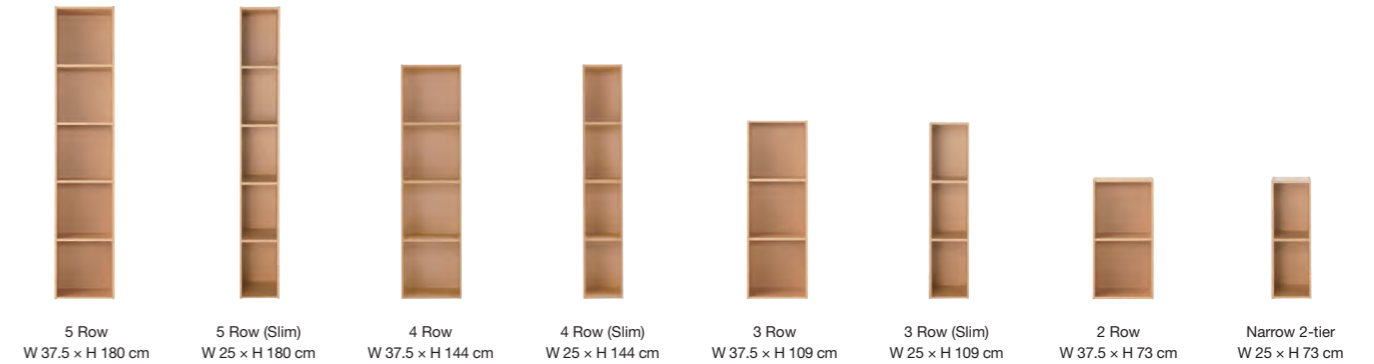

※Depth for all types is 29 cm

<b>5 Row</b> 47549201 Withstand load of fixed shelf: 15 kg per compartment, 40 kg total <b>\$63.00</b>	<b>4 Row</b> 18511341 Withstand load of fixed shelf: 15 kg per compartment, 35 kg total <b>\$53.00</b>	<b>3 Row</b> 47549195 Withstand load of fixed shelf: 15 kg per compartment, 25 kg total <b>\$43.00</b>	<b>2 Row</b> 47549188 Withstand load of fixed shelf: 15 kg per compartment, 20 kg total <b>\$26.00</b>
<b>5 Row (Slim)</b> 18121717 Withstand load of fixed shelf: 15 kg per compartment, 40 kg total <b>\$56.00</b>	<b>4 Row (Slim)</b> 18511358 Withstand load of fixed shelf: 15 kg per compartment, 35 kg total <b>\$49.00</b>	<b>3 Row (Slim)</b> 18121700 Withstand load of fixed shelf: 15 kg per compartment, 25 kg total <b>\$39.00</b>	<b>2 Row (Slim)</b> 18121694 Withstand load of fixed shelf: 15 kg per compartment, 20 kg total <b>\$23.00</b>

Inside dimensions of each shelf: W 34 × D 27.5 × H 34 cm  
Inside dimensions of each narrow shelf: W 21.5 × D 27.5 × H 34 cm  
※ 2-tier units should not be stacked vertically as this configuration will be unstable.



**Pulp Shelf Clamps**  
18960941 | 2 Pack **\$3.90**  
Metal fittings to prevent tipping when pulp board boxes are placed sideways. Units placed sideways can be stacked up to five tiers by using these metal joint fittings.  
※ These Pulp Shelf Clamps can only be used with the 3-tier, 4-tier, and 5-tier models.

Notes regarding the metal fittings  
When placing units sideways, be sure to attach the Pulp Shelf Clamps as shown on the left on the rear side of the units in order to prevent tipping.

**Configuration Recommendation by MUJI Interior Advisor**



※The TV is not included as part of the product.  
※Example of a combination with a 40-inch TV.



※The TV is not included as part of the product.  
※Example of a combination with a 32-inch TV.



※The TV is not included as part of the product.  
※Example of a combination with a 40-inch TV.

<b>Pulp Board / Multi Rack</b> 18121724 <b>\$53.00</b> W 37.5 × D 17.5 × H 109 cm Inside dimensions of each shelf: W 34 × D 16 cm Adjustable shelf: 6 shelves (increment of 2.9 cm) Fixed shelf: 1 shelf (4th tier from top) Withstand load: 8 kg per compartment, 25 kg total	<b>Pulp Board / Free Rack Narrow</b> 18121731 <b>\$49.00</b> W 25 × D 29 × H 109 cm Inside dimensions of each shelf: W 21.5 × D 27.5 cm Adjustable shelf: 3 shelves (increment of 2.9 cm) Fixed shelf: 2 shelves (2nd and 4th tier from top) Withstand load: 8 kg per compartment, 25 kg total
--------------------------------------------------------------------------------------------------------------------------------------------------------------------------------------------------------------------------------------------------------------------------------------------------	------------------------------------------------------------------------------------------------------------------------------------------------------------------------------------------------------------------------------------------------------------------------------------------------------------------

The height of the Free rack, Multi rack, and Pulp Unit - 3 have been made uniform to use alongside each other.

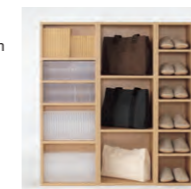

<b>Pulp Board with Casters (Vertical / Horizontal use)</b> 61789712 <b>\$79.00</b> Placed upright: Approx. W62 (inclusive of the handle) x D29 x H79 cm Inside dimensions of shelf: 9 different widths (Approx. 16-37cm), D27 x H34 cm Withstand Load: Fixed shelf 15 kg, total 20 kg Placed on its side: Approx. W76 (inclusive of the handle)x D29 x H64 cm Inside dimensions of shelf: Approx. W34 x D27 x 9 different heights(Approx. 16-37cm) Withstand Load: Fixed shelf 15 kg, adjustable shelf 8 kg, total 20 kg Shelf pitch 3cm It can be placed upright or on its side to fit in various spaces. Hanger bars are used, instead of dowels for more secure installation of movable shelves. It comes with casters for easy movement. ※ Once installed, they cannot be removed. Please check the orientation before installing them.
---------------------------------------------------------------------------------------------------------------------------------------------------------------------------------------------------------------------------------------------------------------------------------------------------------------------------------------------------------------------------------------------------------------------------------------------------------------------------------------------------------------------------------------------------------------------------------------------------------------------------------------------------------------------------------------------------------------------------------------------------------------------------------------------------------------------------------------------------------------------------------



# Polypropylene Storage Unit

There is a wide range of cases, stockers, and boxes.

Flexibly combine the items and sizes according to your purpose and available space.

A large drawer-type case that fits perfectly into your closet.

PP Storage Box / W 40 cm	PP Storage Box / W 44 cm	PP Storage Box / W 55 cm	PP Storage Box W 34 cm
<p>W 40 cm H 30 cm L M S</p>	<p>W 44 cm H 30 cm L M S</p>	<p>W 55 cm H 30 cm L M S</p>	<p>W 34 cm H 30 cm L M S</p>
<p>D 65 cm</p>	<p>D 55 cm</p>	<p>D 44.5 cm</p>	<p>D 44.5 cm</p>
<p>M x 3 S x 4 H 72 cm</p>	<p>L x 2 M x 1 S x 2 H 60 cm</p>		

Drawer-type case that can be stacked or fit perfectly into storage furniture.

PP Storage Case / Shallow	PP Storage Case / Deep	PP Storage Case / Extra Shallow	PP Storage Case / Shallow
<p>W 26 cm H 14 cm 12 cm Half</p>	<p>W 26 cm H 14 cm 17.5 cm Half</p>	<p>W 26 cm H 16.5 cm 26 cm 9 cm 2 Drawers 1 Drawer</p>	<p>W 26 cm H 12 cm</p>
<p>D 37 cm</p>	<p>D 37 cm</p>	<p>D 37 cm</p>	<p>D 37 cm</p>
Stacking limit: 6 Units	Stacking limit: 4 Units	Stacking limit: 7 Units / 13 Units	Stacking limit: 10 Units

PP Storage Case / Wide	PP Storage Case / Deep
<p>W 37 cm H 17.5 cm 37 cm 12 cm 9 cm Deep Shallow Extra Shallow</p>	<p>W 26 cm H 17.5 cm</p>
<p>D 26 cm</p>	<p>D 37 cm</p>
Stacking limit: 6 Units / 10 Units / 13 Units	Stacking limit: 6 Units

Carry boxes with a lid. Folding type carry boxes that can be stored compactly are also available.

Storage racks that can be stacked

PP Storage Rack

W 37 cm  
H 26 cm  
D 26 cm  
Front  
Deep Large  
Deep  
Thin  
17.5 cm  
9 cm

A stocker with casters for free movement.

PP Stocker With Caster

W 18 cm  
H 83 cm  
D 40 cm  
Front  
Deep

Assemble-type Wagon

W 29 cm  
H 83 cm  
D 41.5 cm  
Front  
Top

Versatile storage boxes that can be used outdoors

Sturdy Storage Box

60.5 cm  
40.5 cm  
37 cm  
Large  
Small

39 cm

※ To ensure safety, please follow the stacking limit and withstand load requirements.  
 ※ The polypropylene cases have slight differences in size due to the characteristics of material. When stacked, each case may differ slightly in height.

Polypropylene Storage Box / Wide Type (Approx. W 40 x D 65 cm)



**PP Storage Box / Wide Type W 40 cm**  
 15112081 | L **\$29.00**  
 Approx. W 40 x D 65 x H 30 cm  
 Inside dimensions:  
 Approx. W 33 x D 59 x H 24.5 cm  
 Stacking limit: 6 units

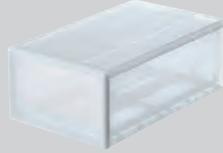

15112098 | M **\$23.00**  
 Approx. W 40 x D 65 x H 24 cm  
 Inside dimensions:  
 Approx. W 33.5 x D 59 x H 18.5 cm  
 Stacking limit: 7 units

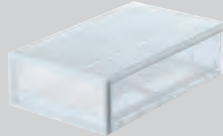

15112104 | S **\$19.00**  
 Approx. W 40 x D 65 x H 18 cm  
 Inside dimensions:  
 Approx. W 33.5 x D 59.5 x H 12.5 cm  
 Stacking limit: 8 units  
 Withstand load (all items):  
 Approx. 7 kg (with casters: approx. 3.5 kg)

Polypropylene Storage Box / Wide Type (Approx. W 44 x D 55 cm)

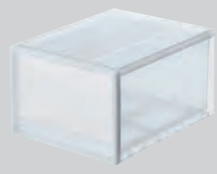

**PP Storage Box / Wide Type W 44 cm**  
 15199693 | L **\$29.00**  
 Approx. W 44 x D 55 x H 30 cm  
 Inside dimensions:  
 Approx. W 38 x D 49.5 x H 24.5 cm  
 Stacking limit: 6 units

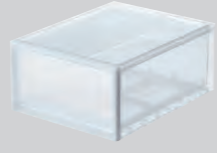

15199709 | M **\$23.00**  
 Approx. W 44 x D 55 x H 24 cm  
 Inside dimensions:  
 Approx. W 38.5 x D 49.5 x H 18.5 cm  
 Stacking limit: 7 units

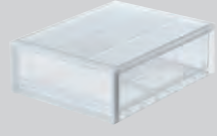

15236640 | S **\$19.00**  
 Approx. W 44 x D 55 x H 18 cm  
 Inside dimensions:  
 Approx. W 38.5 x D 50 x H 12.5 cm  
 Stacking limit: 8 units  
 Withstand load (all items):  
 Approx. 7 kg (with casters: approx. 3.5 kg)

Polypropylene Storage Box / Wide Type (Approx. W 55 x D 44.5 cm)

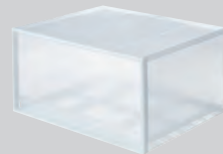

**PP Storage Box / Wide Type W 55 cm**  
 76331476 | L **\$36.00**  
 Approx. W 55 x D 44.5 x H 30 cm  
 Inside dimensions:  
 Approx. W 48.5 x D 39 x H 25 cm  
 Withstand load:  
 Approx. 2.5 kg (with casters: approx. 2.5 kg)  
 Stacking limit: 4 units

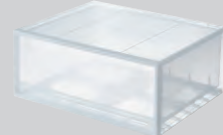

76331483 | M **\$29.00**  
 Approx. W 55 x D 44.5 x H 24 cm  
 Inside dimensions:  
 Approx. W 49 x D 39.5 x H 19.5 cm  
 Withstand load:  
 Approx. 3 kg (with casters: approx. 3.0 kg)  
 Stacking limit: 5 units

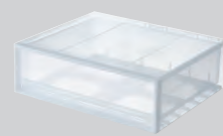

76331490 | S **\$23.00**  
 Approx. W 55 x D 44.5 x H 18 cm  
 Inside dimensions:  
 Approx. W 49 x D 39.5 x H 13.5 cm  
 Withstand load:  
 Approx. 3 kg (with casters: approx. 3.0 kg)  
 Stacking limit: 5 units

Polypropylene Storage Box / Drawer Type (Approx. W 34 x D 44.5 cm)

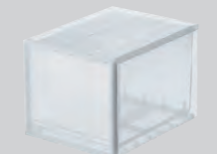

**PP Storage Box / Drawer Type W 34 cm**  
 18816156 | L **\$23.00**  
 Approx. W 34 x D 44.5 x H 30 cm  
 Inside dimensions:  
 Approx. W 28.5 x D 40 x H 25.5 cm  
 Stacking limit: 6 units



18816163 | M **\$19.00**  
 Approx. W 34 x D 44.5 x H 24 cm  
 Inside dimensions:  
 Approx. W 28.5 x D 40 x H 19.5 cm  
 Stacking limit: 7 units

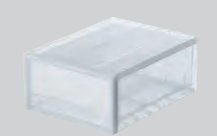

18816170 | S **\$16.00**  
 Approx. W 34 x D 44.5 x H 18 cm  
 Inside dimensions:  
 Approx. W 29 x D 40 x H 13.5 cm  
 Stacking limit: 9 units  
 Withstand load (all items):  
 Approx. 5 kg (with casters: approx. 3.0 kg)

**PP Storage Box / Wide**

82243932 | L / 4 Drawers **\$99.00**

Approx. W 55 x D 44.5 x H 90 cm  
 Stacking limit: 5 drawers  
 (Up to 1 unit of Storage Box Wide can be added)

82243925 | L / 3 Drawers **\$73.00**

Approx. W 55 x D 44.5 x H 67.5 cm  
 Stacking limit: 5 drawers  
 (Up to 2 units of Storage Box Wide can be added)

Inside dimensions (all items):  
 Approx. W 49 x D 39.5 x H 19.5 cm  
 Withstand load (all items):  
 Approx. 9 kg (Approx. 3 kg per drawer) (with casters: Approx. 3 kg per drawer)

PP Storage Box / Drawer-type / Wide can be combined with 1 unit of PP Storage Box Wide.

※ Please note that the set cannot be disassembled again once it has been put together or add drawers later on.

Polypropylene Storage Case / Extra Shallow (Approx. W 26 x D 37 cm)

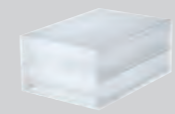

**PP Storage Case / Extra Shallow**  
 76749073 | 2 Drawers **\$19.00**  
 Approx. W 26 x D 37 x H 16.5 cm  
 Stacking limit: 7 units

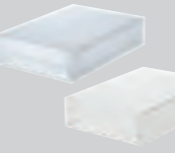

76749066 | 1 Drawer **\$13.00**  
 02108281 | 1 Drawer / White Grey **NEW** each  
 Approx. W 26 x D 37 x H 9 cm  
 Stacking limit: 13 units

Inside dimensions (all items):  
 Approx. W 22.5 x D 34 x H 5.5 cm  
 Withstand load (all items) (with/without casters):  
 Approx. 2 kg per drawer, approx. 2 kg on top board



Polypropylene Storage Case / Shallow (Approx. W 26 x D 37 cm)



**PP Storage Case / Shallow**  
 37192423 | 1 Drawer **\$14.90**  
 15253579 | 1 Drawer / White Grey **NEW** each

Approx. W 26 x D 37 x H 12 cm  
 Inside dimensions: approx. W 22.5 x D 34 x H 8.5 cm  
 Withstand load (with/without casters): approx. 3 kg per drawer, approx. 2 kg on top board



Stacking limit (all items): 10 units



**PP Storage Case / Shallow**  
 37192430 | 3 Drawers **\$29.00**

Approx. W 26 x D 37 x H 32.5 cm  
 Inside dimensions: Approx. W 22.5 x D 34 x H 8.5 cm  
 Withstand load (with/without casters): Approx. 3 kg per drawer, approx. 2 kg on top board



Stacking limit: 3 units

Polypropylene Storage Case / Deep (Approx. W 26 x D 37 cm)



**PP Storage Case / Deep**  
 76749028 | 2 Drawers (with partition) each **\$23.00**  
 02108274 | 2 Drawers (with partition) / White Grey **NEW**

Approx. W 26 x D 37 x H 17.5 cm  
 Inside dimensions: Approx. W 10.5 x D 33.5 x H 14 cm  
 Withstand load (with/without casters): Approx. 2 kg per drawer, approx. 2 kg on top board  
 4 partitions (movable in 4 steps per drawer in increments of approx. 6 cm)



37192447 | 1 Drawer **\$16.00**  
 15253586 | 1 Drawer / White Grey **NEW** each

Approx. W 26 x D 37 x H 17.5 cm  
 Inside dimensions: Approx. W 22 x D 33.5 x H 14 cm  
 Withstand load (with/without casters): Approx. 4 kg per drawer, approx. 2 kg on top board

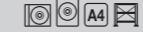

Stacking limit (all items): 6 units



**PP Storage Case / Shallow**

76749035 | 1 Drawer (with dividers) **\$14.90**  
 Approx. W 14 x D 37 x H 17.5 cm  
 Inside dimensions: Approx. W 10.5 x D 33.5 x H 14 cm

Withstand load (with casters): Approx. 2 kg per drawer, approx. 2 kg on top board  
 Stacking limit: 4 units  
 2 Dividers (dividable into 4 sections in 6 cm increments per drawer)



**PP Storage Case / Shallow**  
 76748984 | 2 Drawers (with dividers) **\$19.00**  
 02108304 | 2 Drawers (with dividers) / White Grey each

Approx. W 26 x D 37 x H 12 cm  
 Inside dimensions: approx. W 10.5 x D 34 x H 8.5 cm  
 Withstand load (with casters): approx. 1.5 kg per drawer, approx. 2 kg on top board  
 6 Dividers (dividable into 7 sections in 3 cm increments per drawer)



**PP Storage Case / Shallow**  
 76749042 | 1 Drawer (with dividers) **\$13.00**

Approx. W 14 x D 37 x H 12 cm  
 Inside dimensions: Approx. W 10.5 x D 34 x H 8.5 cm  
 Polypropylene, uncoloured  
 Withstand load (with casters): Approx. 1.5 kg per drawer, approx. 2 kg on top board  
 Stacking limit: 6 units  
 3 Dividers (dividable into 7 sections in 3 cm increments per drawer)



**PP Case / Drawer-type / Shallow**  
 76749004 | 6 Drawers (with dividers) **\$49.00**

Approx. W 26 x D 37 x H 32.5 cm  
 Inside dimensions: Approx. W 10.5 x D 34 x H 8.5 cm  
 Withstand load (with casters): Approx. 1.5 kg per drawer, approx. 2 kg on top board  
 18 Dividers (dividable into 7 sections in 3 cm increments per drawer)



37192430 | 3 Drawers **\$29.00**  
 Approx. W 26 x D 37 x H 32.5 cm  
 Inside dimensions: Approx. W 22.5 x D 34 x H 8.5 cm  
 Withstand load (with casters): Approx. 3 kg per drawer, approx. 2 kg on top board



Stacking limit: 3 units

**Polystyrene Partition**



**Polystyrene Partition**  
 38369622 | L / 4pieces **\$14.90**  
 Approx. W 65.5 x D 0.2 x H 11 cm  
 38369615 | M / 5pieces **\$7.90**  
 Approx. W 36 x D 0.2 x H 7 cm  
 38369608 | S / 5pieces **\$5.90**  
 Approx. W 36 x D 0.2 x H 4 cm



Large Medium Small

**Non-woven Fabric Partition Case**



**Non-woven Fabric Partition Case**  
 02110482 | L / 2pieces **\$16.00**  
 Approx. W 22.5 x D 32.5 x H 21 cm  
 02110475 | M / 2pieces **\$13.90**  
 Approx. W 15 x D 32.5 x H 21 cm  
 02110468 | S / 2pieces **\$11.90**  
 Approx. W 11 x D 32.5 x H 21 cm



Large Medium Small

**Optional Parts**



**Stopper For PP Storage Case**  
 47554908 | S / Set of 4 **\$5.90**  
 47554892 | L / Set of 4 **\$5.90**

These stoppers are attachable on polypropylene cases such as Storage Box (W 40 x D 65, W 44 x D 55, and W 34 x D 44.5 cm)

※ Using the stoppers increases the total height of all drawer type polypropylene cases by approx. 1.5 mm and other products by a maximum of 4 mm.



**Caster For PP Storage Case**  
 15523788 | Set of 4 **\$6.30**  
 These casters can be easily attached to the bottom of the following polypropylene cases by inserting the connectors into the holes.

※ Using the casters increases the total height by approx. 3.8 to 4.2 cm (exact height-increase depends on the case used).

※ Do not use casters on tatami, cushion floors, or other soft flooring in order to prevent damage to the floor.

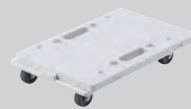

**PP Wheeled Platform / Horizontally & Vertically connectable**  
 82007848 **\$29.90**  
 Approx. W 27.5 x D 41 x H 7.5 cm  
 Withstand load: 80 kg

Each side of a unit can be connected to make it bigger or wider according to the size of the objects to be loaded on it.

**Polypropylene Storage Case / Wide**



**PP Storage Case / Wide / Extra Shallow**  
 15253753 **\$14.90**  
 02108335 | White Grey (NEW) each  
 W 37 x D 26 x H 9 cm  
 Inside dimensions:  
 Approx. W 34 x D 22.5 x H 5.5 cm  
 Withstand load (with/without casters):  
 Approx. 1 kg per drawer, approx. 5 kg on top board (with reinforcement bar)  
 Stacking limit: 13 units



15253777 | 2 Drawers **\$19.00**  
 02118990 | 2 Drawers / White Grey (NEW) each  
 W 37 x D 26 x H 9 cm  
 Inside dimensions:  
 Approx. W 16.5 x D 22.5 x H 5.5 cm  
 Withstand load (with/without casters):  
 Approx. 0.5 kg per drawer, approx. 5 kg on top board (with reinforcement bar)  
 Stacking limit: 13 units



⚠ Please note that above wide drawer-type polypropylene cases cannot be stacked with other drawer-type polypropylene cases.



**PP Storage Case / Wide**  
 15253784 | Shallow **\$16.00**  
 02108328 | Shallow / White Grey (NEW) **\$16.00**  
 W 37 x D 26 x H 12 cm  
 Inside dimensions:  
 Approx. W 33.5 x D 22.5 x H 8.5 cm  
 Withstand load (with/without casters):  
 Approx. 1.5 kg per drawer, approx. 5 kg on top board (with reinforcement bar)  
 Stacking limit: 10 units



15253791 | Deep **\$17.90**  
 02108311 | Deep / White Grey (NEW) each  
 W 37 x D 26 x H 17.5 cm  
 Inside dimensions:  
 Approx. W 33 x D 22.5 x H 14 cm  
 Withstand load (with/without casters):  
 Approx. 2 kg per drawer, approx. 5 kg on top board (with reinforcement bar)  
 Stacking limit: 6 units



**Storage Racks**



**PP Storage Rack**  
 82243963 | L **\$16.00**  
 W 37 x D 26 x H 26 cm  
 Effective Inside dimensions:  
 [Top] Approx. W 33 x D 22.5 x H 24 cm  
 [Bottom] Approx. W 33 x D 22.5 x H 1.5 cm  
 Withstand load: Approx. 5 kg  
 Stacking limit: 4 units



82243956 | M **\$13.90**  
 W 37 x D 26 x H 17.5 cm  
 Effective Inside dimensions:  
 [Top] Approx. W 33 x D 22.5 x H 15.5 cm  
 [Bottom] Approx. W 33 x D 22.5 x H 1.5 cm  
 Withstand load: Approx. 4 kg  
 Stacking limit: 6 units



82243949 | S **\$11.00**  
 W 37 x D 26 x H 9 cm  
 Effective Inside dimensions:  
 [Top] Approx. W 33 x D 24 x H 6.5 cm  
 [Bottom] Approx. W 33 x D 22.5 x H 1.5 cm  
 Withstand load: Approx. 3 kg per drawer  
 Stacking limit: 13 units

※ This unit can be stacked up to 120cm in height.

※ A maximum total withstand weight: Approx. 39kg exclusive of casters, Approx. 19.5kg inclusive of casters, also when any of the stacked units is placed upside down.



**Sturdy Storage Boxes**



**Sturdy PP Storage Box**  
 37525986 | L **\$29.00**  
 Approx. W 60.5 x D 39 x H 37 cm  
 Withstand load: Lid Approx. 100 kg,  
 Storing Area Approx. 13.5 kg  
 Stacking limit: 3 units



**Sturdy PP Storage Box**  
 02478834 | S **\$19.00**  
 Approx. W 40.5 x D 39 x H 37 cm  
 Withstand load: Lid Approx. 100 kg,  
 Storing Area Approx. 13.5 kg  
 Stacking limit: 3 units

## Polypropylene Trolley & Additional Drawer



**PP Storage Case With Caster / 4 Drawers**  
15521821 **\$46.00**  
Approx. W 18 x D 40 x H 83 cm  
Inside dimensions:  
(Drawer) Approx.  
W 13 x D 35.5 x H 17 cm  
☉ ☉ ※ 1



**PP Stoker With Caster / 1**  
15880188 **\$49.00**  
Approx. W 18 x D 40 x H 83 cm  
Inside dimensions:  
(Drawer) Approx. W 13 x D 35.5 x H 17 cm  
(Deep drawer) Approx. W 12.5 x D 35 x H 26.5 cm  
☉ ☉ A4 P ※ 1



**PP Stoker With Caster**  
15880195 | L / Set of 4 **\$56.00**  
Approx. W 18 x D 40 x H 83 cm  
Inside dimensions:  
(Drawer) Approx. W 13 x D 35.5 x H 17 cm  
(Deep drawer) Approx. W 12.5 x D 35 x H 26.5 cm  
(Shallow drawer) approx. W 13 x D 36 x H 7 cm  
☉ ☉ A4 ※ 1



**PP Additional Drawer**  
15880171 | L **\$11.00**  
Approx. W 18 x D 40 x H 11 cm  
Inside dimensions:  
Approx. W 13 x D 36 x H 7 cm  
Stacking limit: 10 units  
47721584 **\$13.00**  
Approx. W 18 x D 40 x H 21 cm  
Inside dimensions:  
Approx. W 13 x D 35.5 x H 17 cm  
Stacking limit: 5 units  
☉ ☉

15880164 | Deep **\$19.00**  
Approx. W 18 x D 40 x H 30.5 cm  
Inside dimensions:  
Approx. W 12.5 x D 35 x H 26.5 cm  
Stacking limit: 4 units  
☉ ☉ A4

※ Remove the top board or casters to add additional drawers and create your own original set.  
※ Can be stacked up to about 122 cm in height in any combination.

## Wagon



**PP Shelf Wagon With Caster**  
15253807 | 3 tiers **\$29.00**  
W 29 x D 41.5 x H 83 cm  
Inside dimensions:  
Approx. W 26 x D 37 x H 22 cm  
(Top board inside dimensions:  
W 26 x D 37.5 cm)  
Withstand load:  
Total: Approx. 8 kg  
(per drawer: 2 kg)

## Soft Polyethylene Storage Unit

These storage units use soft polyethylene film material. They can be stacked by using the separately sold lid. They are water and cold-resistant, allowing them to be put to use in a variety of scenes.



**Soft Polyethylene Case / Deep**  
02528560 **\$18.90**  
Approx. W 25.5 x D 36 x H 32 cm  
A4 ☒ ☒



**Soft Polyethylene Case / L**  
38749486 **\$14.90**  
Approx. W 25.5 x D 36 x H 24 cm  
Stacking limit: 2 units  
A4 ☒ ☒



**Soft Polyethylene Case / M**  
38749479 **\$11.90**  
Approx. W 25.5 x D 36 x H 16 cm  
A4 ☒ ☒



**Soft Polyethylene Case / S**  
38749462 **\$8.90**  
Approx. W 25.5 x D 36 x H 8 cm  
A4 ☒ ☒

**Soft PE Case / Lid**  
38749516 **\$3.90**  
Approx. W 26 x D 36.5 x H 1.5 cm



**Soft Polyethylene Case / Half / L**  
02528577 **\$11.90**  
Approx. W 18 x D 25.5 x H 24 cm  
☒



**Soft Polyethylene Case / Half / M**  
38749509 **\$10.90**  
Approx. W 18 x D 25.5 x H 16 cm  
Stacking limit: 2 units  
☒



**Soft Polyethylene Case / Half / S**  
38749493 **\$7.90**  
Approx. W 18 x D 25.5 x H 8 cm  
☒

**Soft PE Case / Half / Lid**  
38749523 **\$2.90**  
Approx. W 18.5 x D 26 x H 1.5 cm

The storage stoker series is combinations of the following three drawers.

Additional storage units can be stacked up to about 122 cm in height in any combination.

	Weight limit (including when casters are attached)			Storable amount per drawer
	Storage per drawer	Withstand load of top board	Total	
PP Additional Drawer 47721584	Approx. 5 kg	Approx. 3 kg	Approx. 30 kg	About ten 350 ml cans
PP Additional Drawer 15880171 Shallow	Approx. 2.5 kg	Approx. 3 kg	Approx. 30 kg	
PP Additional Drawer 15880164 Deep	Approx. 5 kg	Approx. 3 kg	Approx. 30 kg	About four 1000 ml plastic bottles

※ The height limit includes the height of the casters (approx. 4.2 cm) when attached.  
※ Using the product with lighter objects stored in the upper drawers and heavy ones in the bottom drawers can increase the stability and improve the usability.

◆ Please note the set cannot be disassembled again once it has been put together.

※ 1 Limit of additional storage (adding from the top): 15880171 | Shallow; up to 3 additional tiers, 47721584 | Drawer; add up to 2, 15880164 | Deep; add 1.



Medium, Small, Case Lid

Can be stacked when lids are used.



Half / Small

Cases are cold-resistant so they can also be used as seasoning containers in refrigerators.



## Buri Storage Unit

Hand-woven using high quality uncoated, unbleached buri from the Philippines that keeps its natural texture. Some of these highly functional storage baskets also come with lids and handles.



**Stackable Buri Basket Rectangular / L**  
18014002  
Approx. W 37 x D 26 x H 24 cm  
\$26.00  
A4



**Stackable Buri Basket Rectangular / M**  
47027914  
Approx. W 37 x D 26 x H 16 cm  
\$19.00  
A4



**Stackable Buri Basket Rectangular / S**  
47027907  
Approx. W 37 x D 26 x H 12 cm  
\$16.00  
A4



**Stackable Buri Box Rectangular**  
47027921  
Approx. W 26 x D 18.5 x H 12 cm  
\$13.00

**Buri Basket Lid / Rectangular**  
18014026  
Approx. W 37 x D 26 x H 2 cm  
\$6.90  
\*This lid can be used with S, M, and L buri baskets.

**Buri Box Lid / Rectangular**  
18014033  
Approx. W 26 x D 18.5 x H 2 cm  
\$5.30



**Buri Basket Square / XL**  
47027945  
Approx. W 35 x D 37 x H 32 cm  
\$36.00



**Stackable Buri Basket Square / L**  
18013999  
Approx. W 35 x D 37 x H 24 cm  
\$33.00



**Stackable Buri Basket Square / M**  
47027938  
Approx. W 35 x D 37 x H 16 cm  
\$23.00

**Buri Basket Lid / Square**  
18014019  
Approx. W 35 x D 37 x H 2 cm  
\$9.30  
\*This lid can be used with M, L, and XL buri baskets.

## Rattan Storage Unit

Rattan storage is light and easy to handle, as well as smooth to the touch. These stackable storage items are designed for ease of use, with convenient lids and handles.



**Stackable Rattan Basket Rectangular / L**  
47381313  
Approx. W 36 x D 26 x H 24 cm  
\$49.00  
A4



**Stackable Rattan Basket Rectangular / M**  
47381306  
Approx. W 36 x D 26 x H 16 cm  
\$39.00  
A4



**Stackable Rattan Basket Rectangular / S**  
47381290  
Approx. W 36 x D 26 x H 12 cm  
\$33.00  
A4



**Stackable Rattan Box With Lid Rectangular**  
47381337  
Approx. W 26 x D 18 x H 16 cm  
\$36.00

**Stackable Rattan Basket Lid Rectangular**  
15004768  
Approx. W 36 x D 26 x H 3 cm  
\$16.00  
\*Can be used with L / M / or S.



**Stackable Rattan Box Rectangular / S**  
47381238  
Approx. W 26 x D 18 x H 12 cm  
\$33.00



**Rattan Box With Handle**  
47028454  
Approx. W 15 x D 22 x H 9 cm  
\$23.00



**Stackable Rattan Basket Square / L**  
18021826  
Approx. W 35 x D 36 x H 24 cm  
\$79.00



**Stackable Rattan Basket Square / M**  
18021833  
Approx. W 35 x D 36 x H 16 cm  
\$56.00

**Stackable Rattan Basket Lid Square**  
15004775  
Approx. W 35 x D 36 x H 3 cm  
\$19.00  
\*Can be used with L or M.



**Stackable Rattan Box Rectangular / SS**  
37525702  
Approx. W 26 x D 9 x H 6 cm  
\$16.00



**Stackable Rattan Basket Rectangular / XL**  
38309819  
Approx. W 36 x D 26 x H 31 cm  
\$76.00  
A4



The baskets come with sturdy frames and close fitting lids.

### Country of origin of Rattan Basket

Rattan baskets sold by MUJI are made in Thai Binh province, northern Vietnam. Thai Binh province is a peaceful place with ricefields and free-range cows, buffalos, pigs, and chickens. In addition to farming, the area is also famous for its handcrafts, particularly items of woven rattan and bamboo.



### Making a Rattan Basket

The rattan, about 3-5 cm in diameter, must first be split into 5-9 mm strips before it can be used to make a basket. The rattan baskets are woven by hand, by farmers. This rattan basket takes a long time to weave, only 1-2 can be made in a day.



Usage example

## Cotton Linen Storage Unit

Coated on the inside, these fabric boxes can be folded compactly. The boxes are made based on MUJI's original size standard, which allow them to be combined with shelves and other items.



**Cotton Linen Box Rectangular / L**  
38369738 **\$19.90**  
Approx. W 37 x D 26 x H 34 cm  
A4



**Cotton Linen Box Rectangular / M / With Lid**  
38369769 **\$20.90**  
Approx. W 37 x D 26 x H 26 cm  
A4



**Cotton Linen Box Rectangular / M**  
38369776 **\$16.90**  
Approx. W 37 x D 26 x H 26 cm  
A4



**Cotton Linen Box Rectangular / S**  
38369752 **\$13.90**  
Approx. W 37 x D 26 x H 16 cm  
A4



**Cotton Linen Box / L / With Lid**  
38369721 **\$27.90**  
Approx. W 35 x D 35 x H 32 cm  
A4



**Cotton Linen Box / L**  
38369714 **\$20.90**  
Approx. W 35 x D 35 x H 32 cm  
A4



**Cotton Linen Box Clothes Case / L**  
38369707 **\$36.00**  
Approx. W 59 x D 39 x H 23 cm  
A4



**Cotton Linen Box Clothes Case / S**  
38369745 **\$27.90**  
Approx. W 59 x D 39 x H 18 cm  
A4



**Cotton Linen Box Square / S / With Lid**  
38369691 **\$20.90**  
Approx. W 35 x D 35 x H 16 cm  
A4



**Cotton Linen Box Square / S**  
38369684 **\$16.90**  
Approx. W 35 x D 35 x H 16 cm  
A4



**Cotton Linen Box / Shallow Half**  
38369660 **\$9.90**  
Approx. W 13 x D 37 x H 12 cm  
A4



**Cotton Linen Box Rectangular / S Half**  
38369677 **\$10.90**  
Approx. W 18.5 x D 26 x H 16 cm  
A4

## Stainless Steel and Zinc Storage Unit

MUJI's wire baskets make good use of sturdy stainless-steel. Not only do the handles make them easy to carry around, but the handles can be folded inside when stacking the baskets. The zinc boxes are easy to use and perfect for keeping commodity stocks.

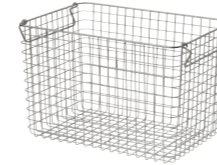

**18-8 Stainless Steel Wire Basket / 5**  
15117079 **\$49.00**  
Approx. W 37 x D 26 x H 24 cm  
Withstand load: 10 kg, Stacking limit: 2 units  
A4



**18-8 Stainless Steel Wire Basket / 4**  
15117062 **\$43.00**  
Approx. W 37 x D 26 x H 18 cm  
Withstand load: 5 kg, Stacking limit: 2 units  
A4



**18-8 Stainless Steel Wire Basket / 3**  
15117055 **\$39.00**  
Approx. W 37 x D 26 x H 12 cm  
Withstand load: 5 kg, Stacking limit: 2 units  
A4



**18-8 Stainless Steel Wire Basket / 2**  
15117048 **\$33.00**  
Approx. W 37 x D 26 x H 8 cm  
Withstand load: 5 kg, Stacking limit: 2 units  
A4

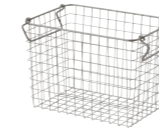

**18-8 Stainless Steel Wire Basket / 1**  
15117031 **\$29.00**  
Approx. W 26 x D 18 x H 18 cm  
Withstand load: 5 kg, Stacking limit: 2 units  
A4



**Zinc Box / Large**  
61417691 **\$33.00**  
Approx. W 25.5 x D 36 (including handles) x H 21 cm



**Zinc Box / Medium**  
61417707 **\$26.00**  
Approx. W 20 x D 29 (including handles) x H 15 cm



Soft Box / With Zip / Small  
Equipped with partitions, these are handy for organising items that easily lose their shape.

## Hard Pulp Box and Steel Tool Box

Storage units that use fibre boards, which are commonly used in industrial pallets and boxes for transportation. Made from 45 to 50% recycled paper, the thickness is achieved by not using glue. Steel Tool Boxes are useful for various purposes and nicely blend into your room.



**Hard Pulp Box / Drawer Deep**  
15967162 **\$33.00**  
Approx. W 25.5 x D 36 x H 16 cm (with anti-slip pad)  
Inner dimensions:  
approx. W 23 x D 34 x H 14 cm  
Withstand load: 2kg  
Stacking limit: 3 units

The size of this item is based on the same size-standard as the Unit Shelf.



**Hard Pulp Box / Drawer 2 Rows**  
15967179 **\$43.00**  
Approx. W 25.5 x D 36 x H 16 cm (with anti-slip pad)  
Inside dimensions:  
approx. W 23 x D 34 x H 6.5 cm  
Withstand load: 1.5 kg  
Stacking limit: 3 units

The size of this item is based on the same size-standard as the Unit Shelf.



**Hard Pulp Box / Drawer 2 Rows**  
15967087 **\$59.00**  
Approx. W 36 x D 25.5 x H 16 cm (with anti-slip pad)  
Inside dimensions:  
approx. W 34 x D 24 x H 6.5 cm  
Withstand load: 1.5 kg  
Stacking limit: 2 units

Stores everything from documents to stationery. The size of this item is based on the same size-standard as the Stacking Shelf.



**Hard Pulp Box / Drawer 4 Rows**  
15967223 **\$59.00**  
Approx. W 36 x D 25.5 x H 16 cm (with anti-slip pad)  
Inside dimensions:  
approx. W 16 x D 24 x H 6.5 cm  
Withstand load: 2 kg  
Stacking limit: 2 units

A box with small compartments. This drawer unit with smaller drawers has the perfect depth for organising letters, bills, and envelopes



**Hard Pulp Box / Drawer Deep**  
15967209 **\$59.00**  
Approx. W 38 x D 36 x H 36 cm  
Inside dimensions:  
approx. W 35.5 x D 33 x H 31 cm  
Withstand load: 10 kg

※ Casters cannot be removed.



**Hard Pulp Box / Drawer Deep**  
15967193 **\$36.00**  
Approx. W 25.5 x D 36 x H 32 cm  
Inside dimensions:  
approx. W 23 x D 33.5 x H 31 cm  
Withstand load: 8 kg  
Stacking limit: 2 units

The size of this item is based on the same size-standard as the Unit Shelf.



**Steel Tool Box / 4**  
37845992 **\$39.00**  
Approx. W 38 x D 18 x H 13 cm  
Withstand load: 10 kg



**Steel Tool Box / 3**  
37845947 **\$49.00**  
Approx. W 38 x D 23 x H 10 cm  
Withstand load: approx. 10 kg  
Stacking limit: 2 units



**Steel Tool Box / 2**  
37845886 **\$18.60**  
Approx. W 16 x D 11 x H 6 cm  
Withstand load: approx. 1.5 kg  
Stacking limit: 3 units



**Steel Tool Box / 1**  
37845831 **\$20.90**  
Approx. W 20 x D 11 x H 6 cm  
Withstand load: approx. 1.5 kg  
Stacking limit: 3 units



A durable box that can store newspapers, magazines, etc.



Useful for storing first aid kits and sewing sets. You can also use a magnet.

## Our Approach to Standard Dimensions of Modules

The standard dimensions of modules are based on "shaku", which is a unit of measurement used in the construction of Japanese homes. These dimensions are used in a wide variety of items ranging from large furniture to small storage items. For example, the height of a unit shelf is based on the height of a "kamoi" (lintel) or door, and shelf width is based on the width of a half "ken" (91 cm), so that they can fit neatly within the width of 1 "ken" (182 cm), between two columns.

### Unit shelf module dimensions "175 cm and 86 cm"

The 175 cm height corresponds the height of doors in Japanese homes. The 86 cm width is based on the "ken" (182 cm), which is a unit of measurement used in the construction of Japanese homes. "Outer width 86 cm, inner width 84 cm" which is slightly less than a half "ken" (91 cm), is a standard dimension for MUJI products.

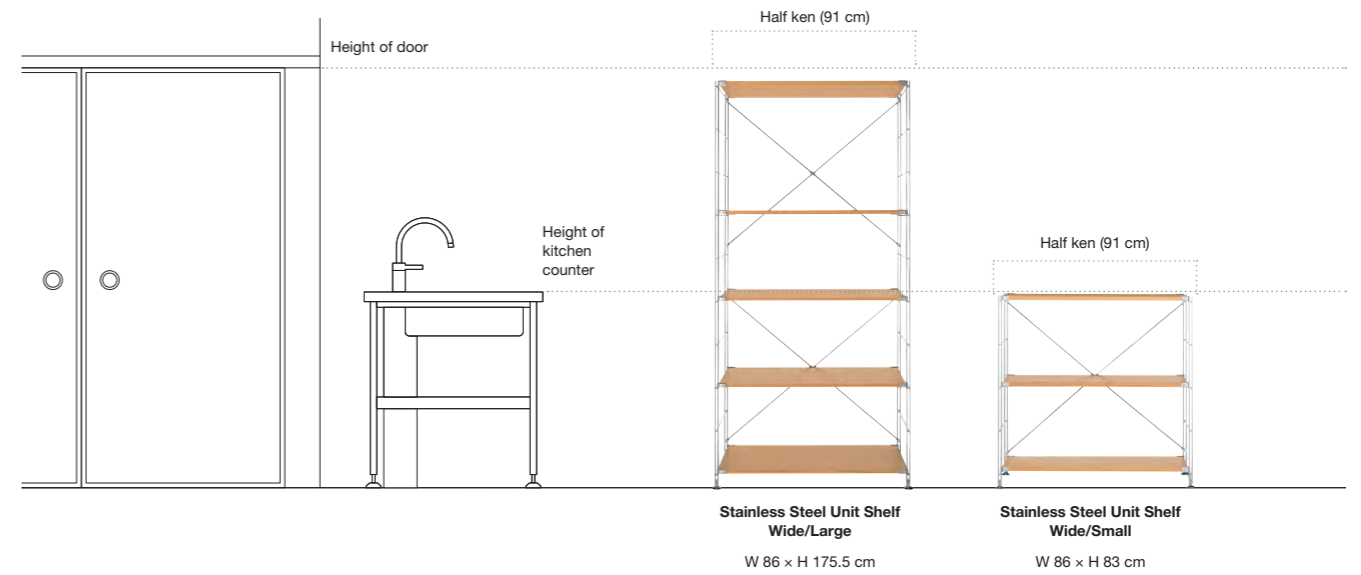

### Storage item module dimensions "37 cm and 26 cm"

Storage item modules are sized to fit neatly in storage furniture with dimensions of 175 cm and 86 cm. The module dimensions of 26 cm and 37 cm, which are designed to fit on shelves, are based on the inside dimensions of shelves (W 80 x H 35 cm).

#### Compatible storage items

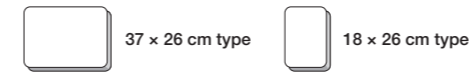

These modules fit in a unit shelf or stacking shelf.

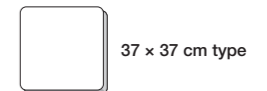

These modules fit in a unit shelf.



37 x 26 cm baskets arranged vertically



Arrangement of 37 x 26 cm and 18 x 26 cm cases



Arrangement of 37 x 37 cm baskets

※ Size varies depending on the material.

## PP Makeup Case

You can choose the polypropylene vanity case best suited to what you want to store inside. Cases of the same size can be stacked for use. Ideal for storing small objects.



**PP Makeup Box**  
37495548 **\$4.90**  
Approx. W 15 x D 22 x H 16.9 cm

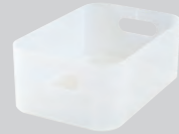

**PP Makeup Box 1/2**  
37495555 **\$3.90**  
Approx. W 15 x D 22 x H 8.6 cm



**PP Makeup Box 1/4**  
37495562 **\$2.90**  
Approx. W 15 x D 22 x H 4.5 cm



**PP Makeup Tray With Mirror**  
37495609 **\$13.90**  
Approx. W 15 x D 22 x H 2 cm  
This product can be placed both vertically and horizontally. Also can be used in place of a lid when combined with PP Vanity Cases.

### PP Makeup Box Lid Type

37495579 **\$3.60**  
Approx. W 15 x D 22 x H 2 cm



**PP Makeup Box With Lid / L**  
37495616 **\$6.90**  
Approx. W 15 x D 22 x H 10.3 cm



**PP Makeup Box With Lid / S**  
37495623 **\$4.90**  
Approx. W 15 x D 11 x H 10.3 cm

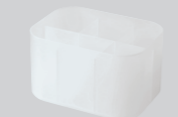

**PP Makeup Box With Partition 1/2**  
37497696 **\$5.30**  
Approx. W 15 x D 11 x H 8.6 cm



**PP Makeup Box With Partition 1/4**  
37497702 **\$3.60**  
Approx. W 15 x D 11 x H 4.5 cm

### PP Makeup Tray / S

37497689 **\$2.30**  
Approx. W 15 x D 11 x H 2 cm



**PP Makeup Box 1/2-Size Width**  
37495586 **\$3.60**  
Approx. W 15 x D 11 x H 8.6 cm



**PP Makeup Box 1/4 Half Height**  
37497764 **\$2.90**  
Approx. W 15 x D 11 x H 4.5 cm



**PP Makeup Box 1/2-Size Long**  
37495593 **\$3.30**  
Approx. W 7.5 x D 22 x H 4.5 cm



**PP Makeup Box**  
37497672 **\$2.60**  
Approx. W 7.1 x D 7.1 x H 10.3 cm

## PP File Box and Cardboard File Box

Made of robust and highly water-resistant polypropylene. These file boxes come in semi-transparent material that allows their contents to be easily identified from the outside and in white grey for neat storage. Convenient for storing documents, magazines and small items, etc. The structure of the cardboard boxes has been improved for easier assembly.



**PP File Box with Handle**  
38654834 **\$16.00**  
38699019 | White Grey each  
Approx. W 10 x D 32 x H 24 cm  
(Height including handle 28.5 cm)



**PP File Box / 25 cm**  
82264579 **\$23.00**  
Approx. W 25 x D 32 x H 24 cm



**PP File Box 1/2 / 25 cm**  
82264524 **\$12.90**  
Approx. W 25 x D 32 x H 12 cm



**PP File Box Lid / Caster Attachable**  
02553135 | For W 25 cm, White Grey **\$7.90**  
02553104 | For 15 cm, Clear **\$6.30**  
02553111 | For 15 cm, White Grey **\$6.30**  
02553081 | For 10 cm, Clear **\$4.60**  
02553098 | For 10 cm, White Grey **\$4.60**  
Approx. D 33 x H 3.5 cm



**PP Open File Box Wide**  
82264326 **\$13.90**  
82264371 | Grey each  
Approx. W 15 x D 32 x H 24 cm



**PP File Box / 10 cm**  
82264227 **\$11.30**  
82264272 | Grey each  
Approx. W 10 x D 32 x H 24 cm



**PP File Box 1/2 Wide**  
82264425 **\$9.60**  
82264470 | White Grey each  
Approx. W 15 x D 32 x H 12 cm  
※1



**PP File Box 1/2 / 10 cm**  
82264128 **\$6.30**  
82264173 | White Grey each  
Approx. W 10 x D 32 x H 12 cm  
※1



**PP Carry Tool Box**  
15915453 **\$13.90**  
37035508 | Grey each  
Approx. W 15 x D 32 x H 8 cm  
(Height including handle 13 cm)  
Withstand load: Approx. 5 kg  
※1

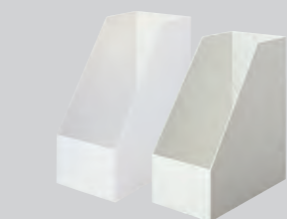

**PP Angle File Box Wide / A4**  
82264029 **\$13.90**  
82264074 | Grey each  
Approx. W 15 x D 27.6 x H 31.8 cm

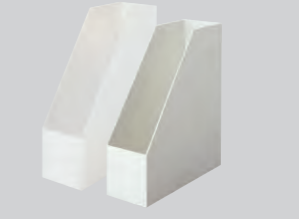

**PP Angle File Box / A4**  
82263923 **\$11.30**  
82263978 | Grey each  
Approx. W 10 x D 27.6 x H 31.8 cm



**PP Unit / A4**  
61154909 | 6 Drawers **\$36.00**  
61164458 | 3 Drawers **\$29.00**  
Approx. W 11 x D 24.5 x H 32 cm



**PP Makeup Box For Cotton Buds**  
37495630 **\$3.30**  
Approx. W 10.7 x D 7.2 x H 9.1 cm



**PP Makeup Box - 1/4 Tall**  
37497665 **\$2.60**  
Approx. W 10.7 x D 7.2 x H 7.7 cm

### Usable as small compartment storage boxes inside drawers.

These can be used as small compartment storage boxes for drawers in polypropylene storage boxes. This makes them useful for neatly organising small office objects such as stationery and storing small items that tend to get separated easily. Features round corners that make it easy to remove items from inside and semi-transparent material that allows you to see objects from the sides.



**Magnet Bar**  
38996460 **\$3.00**  
Approx. W 19 x D 0.4 x H 3 cm  
Magnet bar to be used to attach a small item pocket by hanging on it.



**For PP File Boxes**  
38996477 | Pocket **\$3.00**  
Approx. W 9 x D 4 x H 10 cm  
38996491 | Partitioned Pocket **\$2.30**  
Approx. W 9 x D 4 x H 5 cm  
38996484 | Pen Pocket **\$2.30**  
Approx. W 4 x D 4 x H 10 cm



**PP Stand Carry Case**  
38654834 **\$16.00**  
38699019 | White Grey each  
Approx. W 32 x D 7 x H 24 cm  
(Height including handle 28 cm)



**Expanded PP File Box**  
38996514 **\$20.90**  
Approx. W 10 x D 32 x H 24 cm

※1 Although identical products can be stacked, be careful of stacking too many units. (Up to 3 units is recommended.) As it cannot be secured, please be careful when using it stacked.

## MDF Storage and File Boxes

MDF storage convenient for organizing things on the desk.  
The surface is finished with ash to fit the interior.  
The cardboard box has been redesigned to make it easier to assemble.



**MDF Storage Stand**  
82114836 | A5  
Approx. W 8.4 x D 17 x H 25.2 cm  
**\$26.00**



**MDF Drawer Unit**  
82114805 | 6 tier  
Approx. W 8.4 x D 17 x H 25.2 cm  
**\$59.00**



**MDF Drawer Unit**  
82114799 | 3 tier  
Approx. W 8.4 x D 17 x H 25.2 cm  
**\$49.00**



**MDF Drawer Unit**  
82114782  
Approx. W 25.2 x D 17 x H 8.4 cm  
Includes 1 partition to separate the compartments inside.  
**\$39.00**



**MDF Document Sorting Tray**  
82114820 | A4, 2 slots  
Approx. W 32 x D 24 x H 10.5 cm  
\*Stacking limit: 3 units  
**\$39.00**



**MDF Pen Stand**  
82114812  
Approx. W 11.5 x D 11.5 x H 8.7 cm  
**\$23.00**



**MDF Tissue Box**  
82114843  
Approx. W 26.5 x D 13.5 x H 7.2 cm  
**\$39.00**



**Cardboard File Box Set / 5pc**  
02081355 | A4  
Approx. W 10 x D 32 x H 25 cm  
**\$14.30**



**Cardboard Stand File Box Set / 5pc**  
02081348 | A4  
Approx. W 10 x D 28 x H 32 cm  
**\$14.30**



**Cardboard File Box Set / 5pc**  
38708643 | A4, Dary Grey  
Approx. W 10 x D 32 x H 25 cm  
**\$14.30**



**Cardboard Stand File Box Set / 5pc**  
38708636 | A4, Dary Grey  
Approx. W 10 x D 28 x H 32 cm  
**\$14.30**



Stackable tray that can be used for organizing documents.

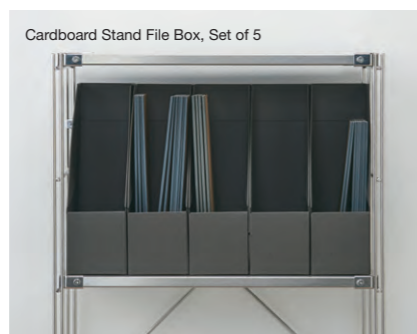

Perfect size where 5 pieces of this product can fit in a unit Shelf W 56 cm.

## Acrylic Storage Unit

Acrylic storage units feature scratch resistance as well as transparency that allows you to identify the contents from the outside. MUJI offers a rich variety of acrylic storage units suitable for any purpose or space, such as on your desktop or in your living room.



**Acrylic Case with Drawer / 2 Rows**  
38300397 | L  
Approx. W 25.5 x D 17 x H 9.5 cm  
Stacking limit: 2 units  
**\$39.00**



**Acrylic Case with Lid / 2 Drawers**  
38970125 | L  
Approx. W 25.5 x D 17 x H 9.5 cm  
Stacking limit: 2 units  
**\$39.00**



**Acrylic Case / 5 Rows**  
15915491 | L  
Approx. W 25.5 x D 17 x H 16 cm  
Stacking limit: 2 units  
**\$59.00**



**Acrylic Case / 3 Rows**  
15915507 | L  
Approx. W 25.5 x D 17 x H 10 cm  
Stacking limit: 2 units  
**\$39.00**



**Acrylic Case with Drawer / 2 Rows**  
47380910  
Approx. W 17.5 x D 13 x H 9.5 cm  
Stacking limit: 2 units  
**\$23.00**



**Acrylic Case with Lid / 2 Drawers**  
47380965  
Approx. W 17.5 x D 13 x H 9.5 cm  
Stacking limit: 2 units  
**\$23.00**



**Velour Inner Box / Grey**  
38373575  
Approx. W 15.5 x D 12 x H 2.5 cm  
**\$9.90**



**Velour Grid Partition / Grey**  
38373544  
Approx. W 15.5 x D 12 x H 2.5 cm  
**\$16.00**

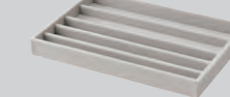

**Velour Partition / Grey**  
38373568 | L  
Approx. W 23.5 x D 15.5 x H 2.5 cm  
**\$16.00**



**Velour Partition for Rings / Grey**  
38373551 | L  
Approx. W 23.5 x D 15.5 x H 2.5 cm  
**\$16.00**



Usage Example



Usage Example



Usage Example



Usage Example

Acrylic Case with Drawer / 2 Rows, Large  
Velour Partition / Grey x2



Two velour boxes placed vertically can be used.

Acrylic Case with Lid / 2 Rows  
Velour Partition 3 x 5 / Grey



Combine velour inner box and partitions to keep items organized.



**Acrylic Storage Stand / A5**  
61798233 **\$23.00**  
Approx. W 8.7 x D 17 x H 25.2 cm



**Acrylic 6 Drawer Unit**  
37268142 **\$49.00**  
Approx. W 8.7 x D 17 x H 25.2 cm



**Acrylic 3 Drawer Unit**  
61798202 **\$39.00**  
Approx. W 8.7 x D 17 x H 25.2 cm

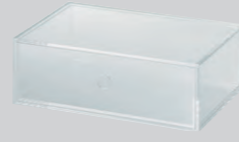

**Acrylic Single Drawer Unit**  
61798196 **\$29.00**  
Approx. W 25.2 x D 17 x H 8.7 cm



**Acrylic Box 6 Drawers / A4**  
38907572 **\$59.00**  
Approx. W 11 x D 24 x H 32 cm



**Acrylic Box 3 Drawers / A4**  
38907572 **\$49.00**  
Approx. W 11 x D 24 x H 32 cm

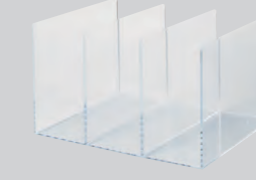

**Acrylic Divider / L**  
15902194 **\$23.00**  
Approx. W 26.8 x D 21 x H 16 cm



**Acrylic Divider / S**  
15902200 **\$19.00**  
Approx. W 13.3 x D 21 x H 16 cm



**Acrylic Stand for Glasses**  
61174280 **\$39.00**  
Closed: Approx. W 6.7 x D 17.5 x H 25 cm



**Acrylic Stand for Pierced Earrings, Necklace**  
18958207 **\$29.00**  
Closed: Approx. W 6.7 x D 13 x H 25 cm



**Acrylic Case Double For Glasses**  
38671497 **\$29.90**  
Closed: Approx. W 17.5 x D 8.8 x H 25 cm  
Opened: Approx. W 35 x D 4.4 x H 25 cm



**Acrylic Case Double for Pierced Earrings, Necklace**  
38671480 **\$29.90**  
Closed: Approx. W 17.5 x D 8.8 x H 25 cm  
Opened: Approx. W 35 x D 4.4 x H 25 cm



**Acrylic Pen Pot Rectangular**  
37528574 **\$2.90**  
Approx. W 5.5 x D 4.5 x H 9 cm

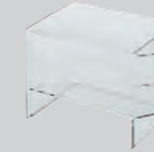

**Acrylic Accessories Rack / L**  
15296309 **\$29.00**  
Approx. W 17.5 x D 13 x H 14.3 cm



**Acrylic Accessories Rack / S**  
15296286 **\$19.00**  
Approx. W 17.5 x D 13 x H 14.3 cm

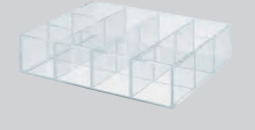

**Acrylic Stand With Partition**  
61407845 **\$29.00**  
Approx. W 25.8 x D 17.5 x H 6.1 cm  
Stacking limit: 2 units



**Velour Inner Box for Glasses / Grey**  
38373520 **\$9.90**  
Approx. W 5 x D 16.5 x H 2 cm



Usage Example



**Velour Partition for Rings / Grey**  
38373537 **\$9.90**  
Approx. W 5 x D 12 x H 2 cm



Usage Example



**Velour Inner Box for Double Case / Grey**  
02119577 **\$9.90**  
Approx. W 3.7 x D 16.7 x H 2 cm



Usage Example

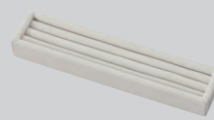

**Velour Partition for Rings, Double Case / Grey**  
02119560 **\$9.90**  
Approx. W 3.7 x D 16.7 x H 2 cm



Usage Example



**Acrylic Storage / 3 Tiers**  
37318533 **\$23.00**  
Approx. W 17.5 x D 6.5 x H 23 cm  
※ Do not store oil-based solutions, such as essential oils and body oils, in this stand.



**Acrylic Partition Shelf / L**  
15919840 **\$13.90**  
Approx. W 26 x D 17.5 x H 16 cm



**Acrylic Partition Shelf / S**  
15919833 **\$11.90**  
Approx. W 26 x D 17.5 x H 10 cm



Usage Example

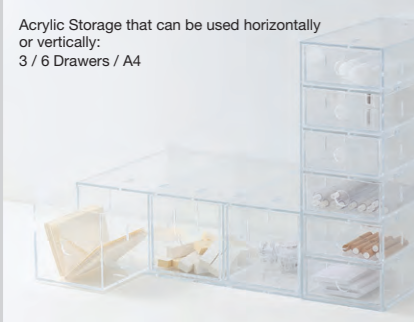

With partitions that further divides the inside, convenient for storing small items.



Can be used on a desk or in a bookshelf.

# ABS Resin Tray

MUJI trays help keep your desk organised by storing documents and stationery, as well as miscellaneous small items. Trays in the same series can be used in combination with each other.



**ABS Tray With Legs**  
37328587 | A4/with 4 legs attached  
**\$23.00**  
Outside dimensions with legs attached:  
Approx. W 24 × D 32 × H 20.8 cm  
Tray portion: Approx. H 4.2 cm  
Inside dimensions:  
Approx. W 23.5 × D 31.5 × H 1.5 cm  
Stacking limit: 2 units  
Total withstand load: 4.5 kg



**ABS Filing Tray**  
37328594 | A4  
**\$19.00**  
Outside dimensions:  
Approx. W 24 × D 32 × H 4.5 cm  
Inside dimensions:  
Approx. W 23.5 × D 31.5 × H 4.2 cm  
Stacking limit: 3 units  
Total withstand load: 9 kg



**ABS Tray**  
37328600 | A4  
**\$19.00**  
Outside dimensions:  
Approx. W 24 × D 32 × H 4.5 cm  
Inside dimensions:  
Approx. W 23.5 × D 31.5 × H 4.2 cm  
Stacking limit: 3 units  
Total withstand load: 9 kg



**ABS A4 Half Organiser Box**  
38728788 | A4 Half  
**\$20.90**  
Approx. W 12 × D 32 × H 7 cm  
Stacking limit: 3 units



**ABS A4 Document Tray**  
38728771 | A4  
**\$20.90**  
Approx. W 24 × D 32 × H 4.5 cm  
※ Do not place "ABS Tray With Legs" in the same series on these document trays.



Conveniently store pens and various items.



Stack 3 Document Trays to keep your magazines, catalogues and documents organized.



**ABS Tray With Legs**  
37328945 | A5/with 4 legs attached  
**\$16.00**  
Outside dimensions with legs attached:  
Approx. W 16 × D 24 × H 14.7 cm  
Tray portion: Approx. H 2.6 cm  
Inside dimensions:  
Approx. W 15.5 × D 23.5 × H 1 cm  
Stacking limit: 2 units  
Total withstand load: 1.5 kg



**ABS Tray With Partition**  
37328617 | A5  
**\$13.00**  
Outside dimensions:  
Approx. W 16 × D 24 × H 2.9 cm  
Inside dimensions:  
Approx. W 15.5 × D 23.5 × H 2.6 cm  
Stacking limit: 3 units  
Total withstand load: 3 kg



**ABS Tray With Partition**  
37328891 | A6  
**\$11.30**  
Outside dimensions:  
Approx. W 12 × D 16 × H 2.9 cm  
Inside dimensions:  
Approx. W 11.5 × D 15.5 × H 2.6 cm  
Stacking limit: 3 units  
Total withstand load: 1.5 kg



**ABS A6 Tray**  
38728825 | A6  
**\$3.90**  
Approx. W 12 × D 16 × H 1.4 cm



Trays with legs make efficient use of space and keep small, miscellaneous items organized.



Combine stackable trays to store documents and 30 cm rulers.



**ABS A7 Stand With Partition**  
37328938  
**\$11.30**  
Outside dimensions:  
Approx. W 8 × D 11 × H 8 cm  
Inside dimensions:  
Top; approx. W 7.4 × H 8.2 cm  
Bottom; approx. W 7.4 × H 4.8 cm



**ABS A7 Tray**  
38728832 | A7  
**\$3.00**  
Approx. W 8 × D 12 × H 1.4 cm



**ABS A7 Coin Tray**  
38728801 | A7  
**\$11.30**  
Approx. W 8 × D 12 × H 2.9 cm  
Stacking limit: 3 units



**ABS A7 Tray With Partition**  
38728818 | A7  
**\$11.30**  
Approx. W 8 × D 12 × H 2.9 cm  
Stacking limit: 3 units



**ABS A7 Box**  
38728795 | A7  
**\$11.30**  
Approx. W 8 × D 12 × H 7 cm



Combine smaller trays to store small items and find them easily.

※ Do not allow the resin material to come in contact with chemicals such as alcohol, oil, thinner, polish remover, strong acid, or strong alkali, as they may cause discolouration or deformation.  
※ To prevent scratches when cleaning, avoid using cleansers, abrasive powder, or hard materials such as scouring pads.  
※ Due to the characteristics of the material, stains or smudges may be visible on the surface.  
※ To clean the resin material, gently wipe with a soft cloth soaked in a neutral detergent diluted with 50% water.  
※ Do not use an acidic detergent for cleaning. Doing so may result in deformation.

# MUJI INTERIOR ADVISOR SERVICE

## Consult us on furnishings just right for you.

Interior Advisor



Look for a staff member with this badge

We will work with our customers individually to help them address their specific storage concerns, furniture selection and placement, or coordinate an entire home.

### Room Layout

Using simulation software, interior advisors are able to show you a variety of furniture layout options as well as coordinate colours on the spot.



Visualise how your room could look with our **3D Simulation Software**

Free of charge



### Tidying and Storage

They will help you identify your storage needs and guide you through selecting items best suited for your interior.

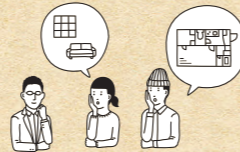

**Suggestions**

on ways you can organise and store your items

Free of charge



### Selection of products

While sharing with you tips on selecting products they'll help you find the items that suit your preferences and needs.

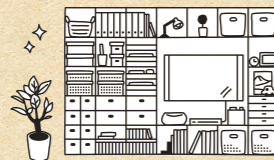

**Advice with choosing sofas**  
adapted to the size of the room and its usage

Free of charge



**Advice with selecting storage and furniture**  
adapted to the space you want to organise

Free of charge

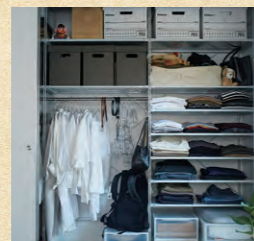

**Advice with choosing beds and bedding**  
adapted to meet the occupants needs

Free of charge



### Contact us

Consultation with an Interior Advisor can be arranged in the store, over the phone, or via e-mail.

※ Consultation services are available at selected stores and by appointment only.  
※ Find out more at [www.muji.com/sg/shop/advisor](http://www.muji.com/sg/shop/advisor)



In-store



Phone



E-mail

[muji\\_IA@muji.com.sg](mailto:muji_IA@muji.com.sg)

### About the symbols used in this catalogue

Product that requires a Phillips screwdriver

Assembly possible by 1 person

Assembly required + required time for assembly (minutes)

Assembly possible by 2 or more persons

#### Storage & Storage Units

Accommodates A4-sized documents

Accommodates CDs

Product that fits into a unit shelf

Accommodates DVDs

Product that fits into a stacking shelf

### HOME DELIVERY

Delivery Time	Delivery charges for purchases below S\$500	Delivery charges for purchases above S\$500
<b>Monday - Friday</b>		
10:00am - 7:00pm	S\$40	Free
7:00pm - 9:00pm	S\$60	S\$20
<b>Saturday</b>		
10:00am - 7:00pm	S\$60	S\$20

No deliveries on Sunday and Public Holidays.  
Labour charge for walk-up apartment is at S\$10 per level per item (up to a maximum of S\$200).  
Delivery service is based on single destination within Singapore only.

Please approach our staff for further enquiries.  
Alternatively, call us at 6261 1813 or email us at [homedelivery@muji.com.sg](mailto:homedelivery@muji.com.sg)

**Business Hours:**  
Monday - Friday, 10:00am - 7:00pm  
Saturday, 10:00am - 2:00pm  
Closed on Sunday and Public Holidays

MUJI (SINGAPORE) Pte Ltd reserves the right to amend the above Terms & Conditions without prior notice.



# MUJI

無印良品

<b>313@somerset</b>	#B2-38 to 41 & 47 to 49	Tel: 6634 5053
<b>Bugis Junction</b>	#03-10F	Tel: 6634 5053
<b>Changi Airport T2</b>	#026-024-01, Departure	Tel: 6546 6421
<b>ION Orchard</b>	#B4-13 to 16	Tel: 6336 7885
<b>Jem</b>	#04-33 to 37	Tel: 6509 9321
<b>Jewel Changi Airport</b>	#02-227 to 229	Tel: 6241 1385
<b>Marina Square</b>	#02-326 to 330	Tel: 6339 2558
<b>Paragon</b>	#04-36 to 40	Tel: 6336 6123
<b>Plaza Singapura</b>	#01-10 to 17	Tel: 6264 5838
<b>Raffles City</b>	#02-20/22	Tel: 6264 4189
<b>Tampines 1</b>	#03-06/07	Tel: 6509 9733
<b>VivoCity</b>	#02-198	Tel: 6376 8023

[www.muji.com/sg/](http://www.muji.com/sg/)

[www.facebook.com/muji.sg](https://www.facebook.com/muji.sg)

[www.instagram.com/mujisg](https://www.instagram.com/mujisg)

